

archiutti | office furniture

# Ar.tu



archiutti



# Ar.tu

Purezza e rigore nei volumi, alternanza tra pieni e vuoti, giochi di materiali differenti: questi i segni distintivi di Ar.tu. Un inserto in metallo unisce e definisce le aree del piano. L'accostamento del laccato lucido e opaco, delle essenze lignee in rovere sbiancato o cotto, noce canaletto e della pelle crea il design di scrivanie, madie e librerie.

product design **Perin & Topan**

Pure, simple volumes, alternations of solid and empty forms and a variety of materials: these are the key features of Ar.tu. A metal insert combines and defines the desktop areas. The combination of shiny and matt lacquered finishes, bleached and cooked oak and American walnut woods and leather gives desks, low cupboards and bookshelves outstanding design values.

Pureté et rigueur dans les volumes, alternance entre les pleins et les vides, jeux de matériaux différents: tels sont les signes caractéristiques d'Ar.tu. Un insert en métal unit et définit les zones du plan. Le rapprochement du laqué brillant et mat, des finitions bois chêne blanchi, chêne fumé, noyer d'Amérique et de la finition cuir, crée le design des bureaux, des meubles des bas et des bibliothèques.

Reine und strenge Volumen, Abwechslung zwischen Voll und Leer, Spiele aus unterschiedlichen Materialien: Das sind die kennzeichnenden Merkmale von Ar.tu. Ein Metalleinsatz verbindet und definiert die Bereiche der Ebene. Die Kombination von Hochglanz - mit Mattlack, der Holzarten gebleichte und gebrannte Eiche, sowie Schwarznuss und Leder, gestalten das Design der Schreibtische, Sideboards und Bücherschränke.

# 01

## Creativo

Creative Créatif Kreativ





La scrivania con piano a sbalzo affiancata al muretto esprime il proprio carattere nel contrasto tra il rovere cotto, la luminosità del bianco laccato e la pelle color titanio; madie in essenza e librerie laccate lucide con nicchie coordinate al piano.

The desk with overhanging top alongside the wall asserts a strong personality in the contrast of cooked oak, luminous white lacquered and titanium colour leather; wood veneer low cupboards and shiny lacquered bookshelves with coloured niches to match the desktop.

Le bureau avec plan en porte-à-faux juxtaposé au muret exprime son caractère dans le contraste entre le chêne fumé, la luminosité du blanc laqué et le cuir couleur titane, les meubles bas sont proposés dans la finition bois et les bibliothèques laquées brillantes avec niches assorties au plan.

Der Schreibtisch mit Kragplatte und Seitenblock offenbart seinen Charakter durch den Kontrast zwischen der gebrannten Eiche, der Helligkeit des weißen Lacks und dem titangrauen Leder; hölzerne Sideboards und hochglanzlackierte Bücherschränke mit zur Schreibtischplatte passenden Nischen.



Il muretto è predisposto con top-access per permettere i collegamenti multimediali senza alterare la semplicità e la purezza del sistema.

The panel side allows top-access to allow multimedia connections without detracting from the simplicity and purity of the system's design.

Le muret est prééquipé d'une trappe top-access pour permettre les connexions multimédias sans altérer la simplicité et la pureté du système.

Der Seitenblock besitzt einen Top-access für die multimedialen Anschlüsse, der die Schlichtheit und Reinheit des Systems nicht verändert.



# 02

## Idealista

Idealist Idéaliste Idealist

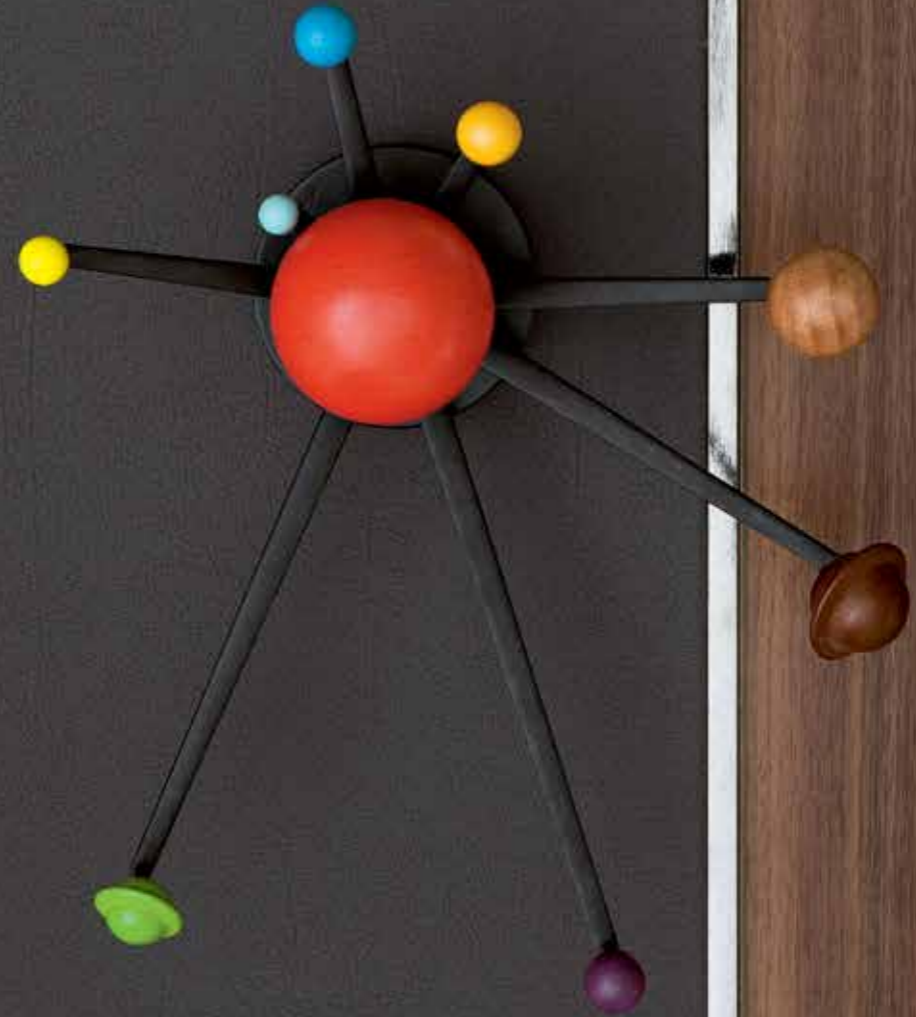



Composizione con piano di lavoro e muretto in noce canaletto e laccata titanio; libreria color titanio laccata lucido e nicchie in poppy red.

Composition with desktop and panel side in American walnut and titanium lacquering; shiny lacquered titanium colour bookshelves and poppy red niches.

Composition avec plan de travail et «muret» en noyer d'Amérique et laqué titane; bibliothèque finition laqué brillant titane et niche en poppy red.

Komposition mit Arbeitsplatte und Seitenblock aus Schwarznuss und titangrauem Lack; Bücherschrank titangrau hochglanzlackiert und Nischen in Farbe Poppy Red.





Le nicchie, inserite all'interno delle librerie ed illuminate a LED, introducono ritmo nella composizione e creano suggestivi giochi di luce.

The niches set into the bookcases, which are illuminated with LED lights, lend rhythm to the design and create an alluring play of light.

Les niches insérées à l'intérieur des bibliothèques et éclairées par des leds introduisent le rythme dans la composition et créent des jeux de lumière suggestifs.

Die in die Bücherschränke eingesetzten und mit Leds beleuchteten Nischen bringen Schwung in die Kombination und gestalten eindrucksvolle Lichtspiele.





# 03

## Dinamico

Dynamic Dynamique Dynamisch





Scrivania con tavolo di servizio e cassetiera coordinata; madia con nicchia a contrasto honey yellow. Finiture rovere cotto e pelle color titanio.

Desk with matching general-purpose table and drawer unit; low cupboard with contrasting honey yellow niche. Cooked oak and titanium colour leather finishes.

Bureau avec table de service et caisson assorti; meuble bas avec niche contrastante honey yellow. Finitions chêne fumé et cuir couleur titane.

Schreibtisch mit Nebentisch und koordiniertem Rollcontainer; Sideboard mit Kontrastnischen in Farbe Honey Yellow. Ausführungen: gebrannte Eiche und titangraues Leder.



Tavolo riunione rettangolare con top-access centrale. Finiture rovere cotto e pelle color titanio.

Rectangular conference table with central top-access. Cooked oak and titanium colour leather finishes.

Table de réunion rectangulaire avec trappe top-access centrale. Finitions chêne fumé et cuir couleur titane.

Rechteckiger Versammlungstisch mit mittigem Top-access. Ausführungen: gebrannte Eiche und titangraues Leder.



La madia, caratterizzata da un'originale nicchia colorata, crea un gioco di pieni e vuoti nel segno continuo delle linee orizzontali presenti su tutti i lati.

The low credenza, which features an original coloured niche, creates a play of solids and voids and features horizontal lines that continue on all sides.

Le meuble bas, caractérisé par une niche colorée originale, crée un jeu de pleins et de vides dans le signe continu des lignes horizontales présentes sur tous les côtés.

Das Sideboard mit der originellen farbigen Nische bildet in Kontinuität mit den allseitig vorhandenen horizontalen Linien ein Spiel aus Voll und Leer.



# 04

## Estroverso

Extroverted Extraverti Extrovertiert





Scrivania a ponte su muretto bianco, finiture in noce canaletto e pelle bianca. Madia in noce canaletto, con nicchia laccata a contrasto di colore bianco. Tavolo riunione quadrato, 160x160 cm, con finitura in noce canaletto e top-access centrale a contrasto in pelle bianca.

Bridge desk supported by a low white side panel, finish in American walnut and white leather. American walnut low credenza with lacquered niche in contrasting shiny white. Square conference table, 160x160 cm, with American walnut finish and central top-access in contrasting white leather.

Bureau suspendu sur muret blanc, finitions en noyer d'Amérique et cuir blanc. Meuble bas en noyer d'Amérique, avec niche contrastante en laqué blanc. Table de réunion carrée, 160x160 cm, avec finition en noyer d'Amérique et trappe top-access centrale contrastante en cuir blanc.

Schreibtischbrücke auf weißer Stützwand, Nussholz Canaletto und weißem Leder. Sideboard aus Nussholz Canaletto, mit weiß lackierter Kontrastnische. Quadratischer Versammlungstisch, 160x160 cm, veredelt mit Nussholz Canaletto und mittigem Top-access in kontrastfarbenem weißem Leder.







Tavolo riunione con top-access centrale, finitura in noce canaletto, basamenti laccati. Madie in noce canaletto con nicchie a contrasto di colore bianco.

Conference table with central top-access, finished in American walnut with lacquered bases. American walnut with lacquered bases. American walnut with contrasting white niches.

Table de réunion avec trappe top-access centrale, finition en noyer d'Amérique avec piétements laqués en couleur blanc. Meubles bas en noyer d'Amérique avec niches contrastantes de couleur blanc.

Versammlungstisch mit mittigem Top-access, veredelt mit Nussholz Canaletto und lackierte Tischbasiselemente. Sideboards aus Nussholz Canaletto, mit weißen Kontrastnischen.

# 05

## Esteta

Aesthete Esthétique Ästhet





Scrivania con piano in pelle bianca e contenitore laccato coordinato; libreria in finitura rovere sbiancato con nicchie bianche.

Desk with white leather top and matching lacquered storage unit; bookcase with bleached oak finish, featuring white niches.

Bureau avec plan en cuir blanc et armoire laquée assorti; bibliothèque finition chêne blanchi avec niches blanches.

Schreibtisch mit Schreibtischplatte aus weißem Leder und koordiniertem Lack-Schränkelement; Bücherschrank aus gebleichter Eiche mit weißen Nischen.



L'accostamento di finiture diverse e la differenziazione delle funzionalità è messo in evidenza dalla luminosità dell'insero in metallo spazzolato.

The combination of different finishes and the distinction between functions is highlighted by the bright brushed metal insert.

Le mélange de finitions diverses et la différenciation des fonctions sont mis en évidence par la luminosité de l'insero en métal brossé.

Die Kombination unterschiedlicher Ausführungen und die Trennung der Funktionen werden vom hellen gebürsteten Metalleinsatz in den Vordergrund gestellt.



# 06

## Intellettuale

Intellectual Intellectuel Intellektuell



Scrivania con piano in pelle e cassetiera laccata tortora; madia tortora con nicchia a contrasto.

Desk with leather top and dove grey lacquered drawer unit; madia tortora low cupboard with contrasting niche.

Bureau avec plan en cuir et caisson laqué tourterelle; meuble bas tourterelle avec niche de couleur contrastante.

Schreibtisch mit Lederplatte und Rollcontainer, taubengrau lackiert; taubengrauer Sideboard mit kontrastfarbener Nische.





Alla scrivania può essere applicato un modesty panel mantenendo la leggerezza compositiva e formale.

The desk can be fitted with a modesty panel with no reduction in its lightness of form and composition.

Le bureau peut être complété par un voile de fond sans compromettre pour autant la légèreté de la composition et de la forme.

Am Schreibtisch kann ein Modesty Panel angebracht werden, der die leichte Wirkung der Komposition und Form nicht verändert.







Scrivania e contenitore  
total white con finiture  
laccate, lucido e opaco;  
madia laccato tortora con  
nicchia coordinata al tavolo.

Total white desk and  
storage unit with shiny  
and matt lacquered finishes;  
dove grey lacquered low  
cupboard with niche  
coloured to match the table.

Bureau et armoire total  
white avec finitions laquées,  
en brillant et mat; meuble  
bas laqué tourterelle avec  
niche assortie à la table.

Schreibtisch und  
Schrankelement total  
white mit matt und  
hochglanzlackierten  
Ausführungen; taubengrau  
lackierter Sideboard mit zum  
Tisch passender Nische.

# 07

## Razionale

Rational Rationnel Rationell





Scrivania a ponte total white, laccato e pelle su contenitore di servizio con struttura laccata bianca lucida e ante in rovere cotto. Piano di appoggio a ponte in rovere cotto.

"Total white" lacquer and leather bridge desk supported by a storage unit with shiny white lacquer structure and cooked oak doors. Bridge shelf top in cooked oak.

Bureau suspendu total white, laqué et cuir sur meuble de service avec structure laquée blanc brillant et portes en chêne fumé. Plan d'appui suspendu en chêne fumé.

Schreibtischbrücke Total White, Lack und Leder auf Schrankelement mit lackierter Struktur in Weiß Hochglanz und Schranktüren aus gebrannter Eiche. Brückenauflage aus gebrannter Eiche.



Il gioco d'incastri dei piani e l'accostamento di finiture in rovere cotto e bianco lucido contribuiscono a sottolineare l'originalità della composizione.

The cleverly joined tops and the combination of cooked oak and shiny white finishes enhance the originality of the design.

Le jeu d'encastrement des plans et l'association des finitions en chêne fumé et blanc brillant contribuent à souligner l'originalité de la composition.

Die ineinander greifenden Flächen und die Kombination von gebrannter Eiche mit weißem Hochglanzlack heben die originelle Art dieser Kombination noch stärker in den Vordergrund.



# 08

## Intraprendente

Enterprising Entrepreneur Unternehmend

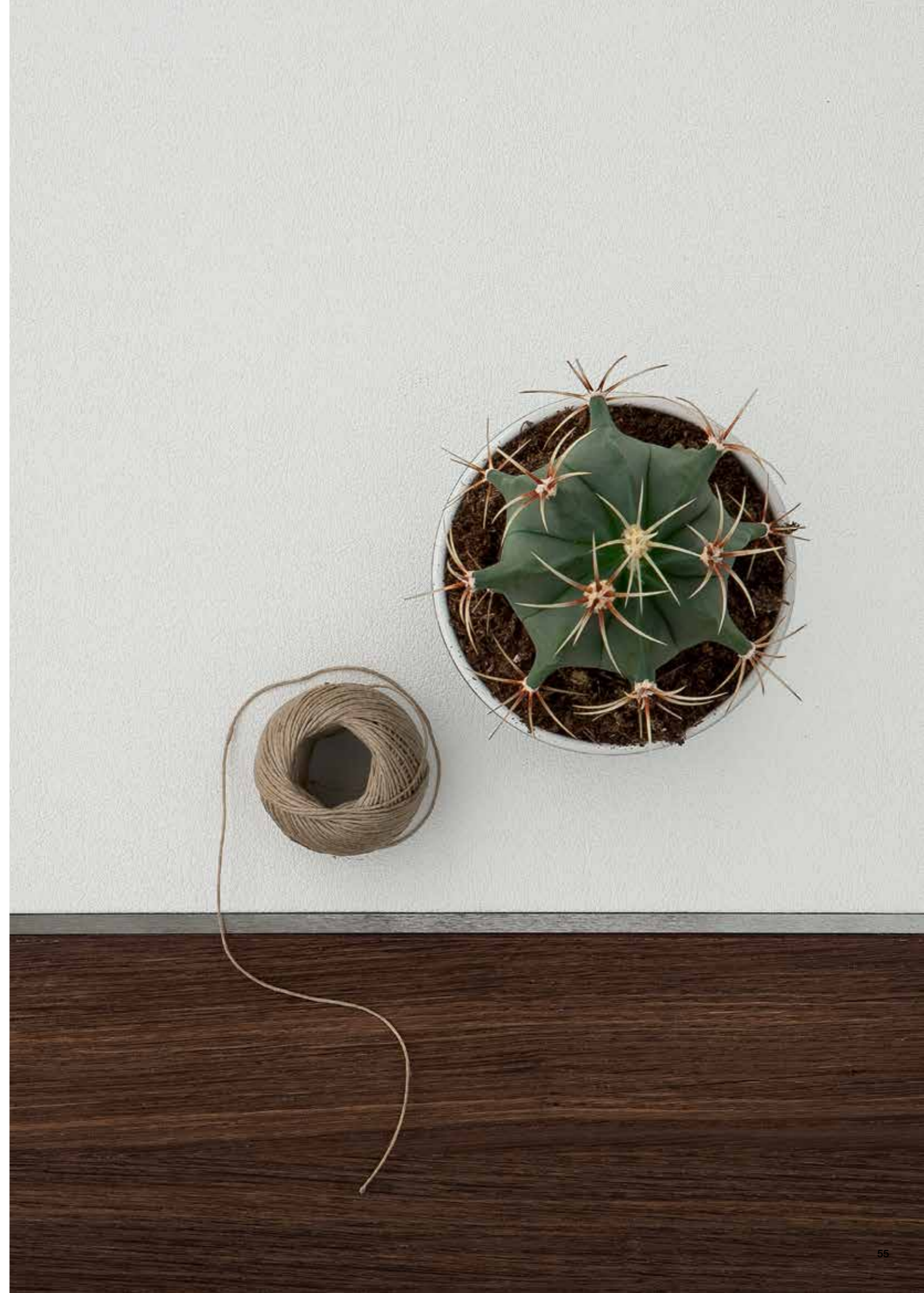



Scrivania a ponte in rovere cotto con piano in pelle bianca e mensola in laccato bianco opaco. Contenitore di servizio in titanio lucido.

Bridge desk in cooked oak with white leather top and matte white lacquer shelf. Storage unit in shiny titanium colour.

Bureau suspendu en chêne fumé avec plan principal recouvert de cuir blanc et plan retour en laqué blanc mat. Meuble de service en titane brillant.

Schreibtischbrücke aus gebrannter Eiche mit Tischplatte aus weißem Leder und Verbindungselement in Weiß matt lackiert. Schrankelement in Titangrau Hochglanz.



La geometria della composizione è sottolineata dall'accostamento di superfici e materiali differenti.

The combination of different surfaces and materials enhances the geometry of the design.

La géométrie de la composition est soulignée par l'association de surfaces et de matériaux différents.

Die Zusammenstellung unterschiedlicher Oberflächen und Materialien betont die Geometrie der Kombination.



**Dettagli scrivanie e tavoli riunione / Details of desks and meeting tables / Détails des bureaux et des tables réunion / Details der Schreibtische und Konfrenztische**



L'inserto in metallo spazzolato caratterizza i piani di lavoro. / The brushed metal insert gives a distinctive touch to the worktops. / L'insert en métal brossé caractérise les plans de travail. / Der gebürstete Metalleinsatz kennzeichnet die Arbeitsplatten.



Le cassettiere possono essere in essenza di legno o laccate lucide, i fianchi sono sempre laccati opaco. / Drawer units may be in wood veneer or lacquered; side panels are always shiny lacquered. / Les caissons sont disponibles dans la finition bois ou en laqué brillant, les côtés sont toujours en laqué mat. / Die Rollcontainer können aus Holz oder hochglanzlackiert sein, die Seitenwände sind immer matt lackiert.



Per garantire una maggiore privacy, la chiave in metallo satinato offre la possibilità di chiudere le ante dei contenitori di servizio. / To ensure privacy, the doors of the storage units can be locked with a satin metal key. / Pour garantir une meilleure confidentialité, la clé en métal satiné permet de verrouiller les portes des meubles de service. / Um mehr Diskretion zu sichern, sind die Türen der Schrankelemente mit dem satinierten Metallschlüssel abschließbar.



Le scrivanie e i tavoli riunione sono dotati di top-access centrale per permettere il collegamento di lampade e cavi necessari alle postazioni multimediali. Il tavolo riunione è adatto ad accogliere situazioni di conferenza. / The desks and conference tables are equipped with central top-access for plugging in lamps and cables for multimedia systems. The conference table is suitable for hosting meetings. / Les bureaux et les tables de réunion sont munis de trappe top-access centrale pour permettre la connexion de lampes et câbles nécessaires aux postes multimédias. La table de réunion est adaptée pour l'utilisation dans des contextes de conférence. / Die Schreibtische und Versammlungstische sind an der Mitte mit Top-access für die Lampen- und Kabelanschlüsse für multimediale Arbeitsplätze ausgestattet. Der Versammlungstisch eignet sich für Konferenzen.

**Finiture / Finishes / Finitions / Ausführungen**

**TAVOLI RIUNIONE (piani centrali e teste) SCRIVANIE (piani, ponte frontale, fianchi), TAVOLO DI SERVIZIO, MURETTO (piano), MOBILI DI SERVIZIO, LIBRERIE E MADIE (ante, top e fianchi), CASSETTIERA (frontali, top, schienale), MODESTY PANEL / CONFERENCE TABLES (central tops and ends), DESKS (tops, front bridge section and side panels), GENERAL-PURPOSE TABLES, WALL (top), SERVICE CABINETS, BOOKSHELVES AND LOW CUPBOARDS (doors, tops and side panels), DRAWER UNIT (front panels, tops and back panel), MODESTY PANELS / TABLES DE RÉUNION (plans centraux et extrémités) BUREAUX (plans, structure frontale en pont, piétements latéraux), TABLE DE SERVICE, MURET (plan), ÉLÉMENTS DE RANGEMENT, BIBLIOTHÈQUES ET MEUBLES BAS (portes, dessus et côtés), CAISSON (façades, dessus, panneau arrière), VOILE DE FOND / VERSAMMLUNGSTISCHE (mittlere Tischplatten und Endteile), SCHREIBTISCHE (Schreibtischplatten, vorderes Brückenelement, Seitenwände), NEBENTISCH, SEITENBLOCK (Platte), SERVICEMÖBEL, BÜCHERSCHRÄNKE UND SIDEBOARDS (Türen, Platte und Seitenwände), ROLLCONTAINER (Fronten, Platte, Rückwand), MODESTY PANEL**

**NOCE CANALETTO**



American walnut / Noyer d'Amérique / Schwarznuß

**ROVERE COTTO**

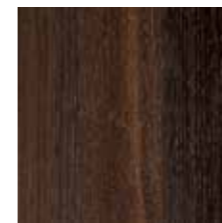

Cooked oak / Chêne fumé / Gebrannte Eiche

**ROVERE SBIANCATO**



Bleached oak / Chêne blanchi / Gebleichte Eiche

**TAVOLI RIUNIONE (basamento titanio o bianco) SCRIVANIE (ponte frontale), MOBILI DI SERVIZIO, LIBRERIE E MADIE (ante, top, fianchi e nicchie), MODESTY PANEL / CONFERENCE TABLES (base titanium or white), DESKS (front bridge section), SERVICE CABINETS, BOOKSHELVES AND LOW CUPBOARDS (doors, tops, side panels and niches), MODESTY PANELS / TABLES DE RÉUNION (base titane ou blanche) BUREAUX (structure frontale en pont), ÉLÉMENTS DE RANGEMENT, BIBLIOTHÈQUES ET MEUBLES BAS (portes, dessus, côtés et niches), VOILE DE FOND / VERSAMMLUNGSTISCHE (Untergestell Titangrau oder Weiß), SCHREIBTISCHE (vorderes Brückenelement), SERVICEMÖBEL, BÜCHERSCHRÄNKE UND SIDEBOARDS (Türen, Platte, Seitenwände und Nischen), MODESTY PANEL**

**SCRIVANIE (piani di lavoro laterali e fianchi), MURETTO (fianco e pannello frontale) CASSETTIERA (fianchi) / DESKS (side worktops and side panels), WALL (side and front panels) AND DRAWER UNIT (side panels) / BUREAUX (plans de travail latéraux et piétements), MURET (côté et voile de fond), CAISSON (côtés) / SCHREIBTISCHE (seitliche Arbeitsplatten und Seitenwände), SEITENBLOCK (Seitenwand und Front), ROLLCONTAINER (Seitenwände)**

**LACCATI LUCIDO / SHINY LACQUERED BOARD / LAQUÉS BRILLANT / LACK HOCHGLANZ**

**LACCATI OPACO / MATT LACQUERED BOARD / LAQUÉS MAT / LACK MATT**

**BIANCO 9010**



White / Blanc / Weiß

**TORTORA**



Dove grey / Tourterelle / Taubengrau

**TITANIO**



Titanium / Titane / Titangrau

**BIANCO 9010**

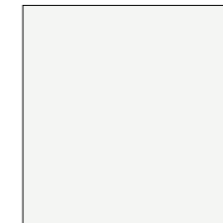

White / Blanc / Weiß

**TORTORA**



Dove grey / Tourterelle / Taubengrau

**TITANIO**



Titanium / Titane / Titangrau

**MADIE (solo nicchie) / LOW CUPBOARDS (niches only) / MEUBLES BAS (seulement niches) / SIDEBOARDS (nur Nischen) LACCATI LUCIDO / SHINY LACQUERED BOARD / LAQUÉS BRILLANT / LACK HOCHGLANZ**

**HONEY YELLOW**



**POPPY RED**



**DUSK BLUE**



**TAVOLI RIUNIONE (piani centrali) SCRIVANIE (piani, top access) / CONFERENCE TABLES (central tops) AND DESKS (tops, top access points) / TABLES DE RÉUNION (plans centraux), BUREAUX (plans, trappes top-access) / VERSAMMLUNGSTISCHE (mittlere Tischplatten), SCHREIBTISCHE (Tischplatten, Top-access) ECO-PELLE / ECO-LEATHER / ECO-CUIR / ECO-LEDER**

**BIANCO**

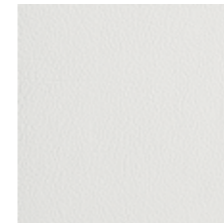

White / Blanc / Weiß

**TORTORA**

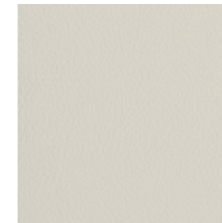

Dove grey / Tourterelle / Taubengrau

**TITANIO**



Titanium / Titane / Titangrau



**Scrivania**  
Desk

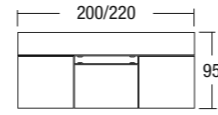
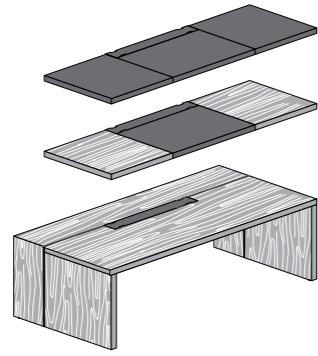
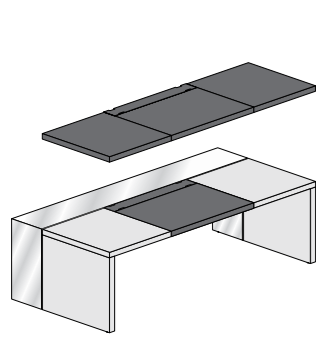

**Scrivania con consolle laterale in legno**  
Desk with side extension in veneer

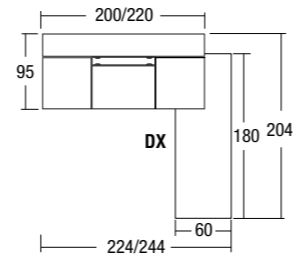
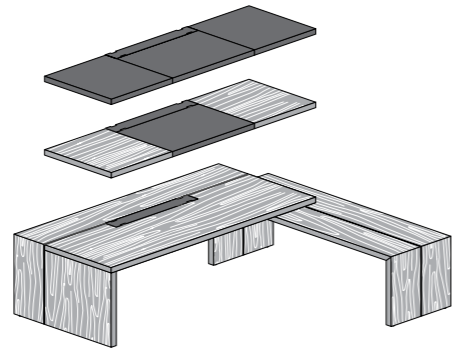
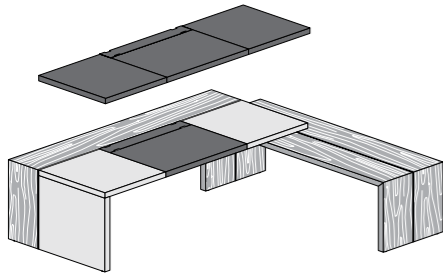

**Scrivania con muretto laterale**  
Desk with side extension

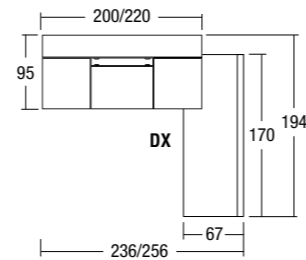
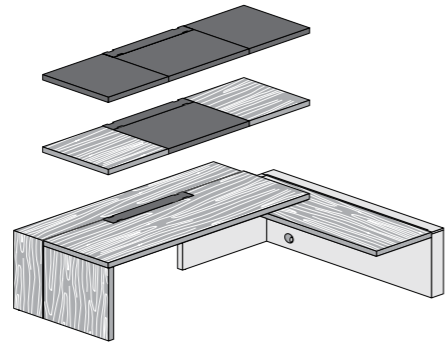
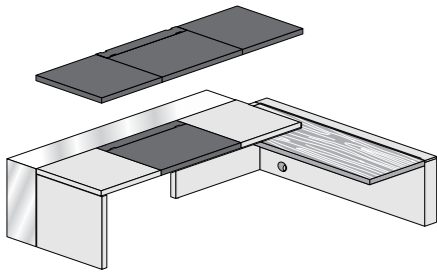

**Scrivania in appoggio (dx/sx) su mobile di servizio**  
Desk supported (r/h) by side container

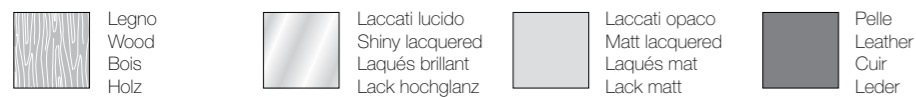
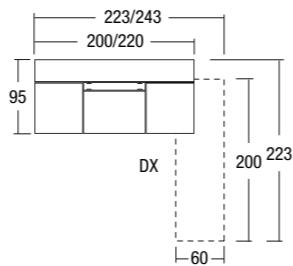
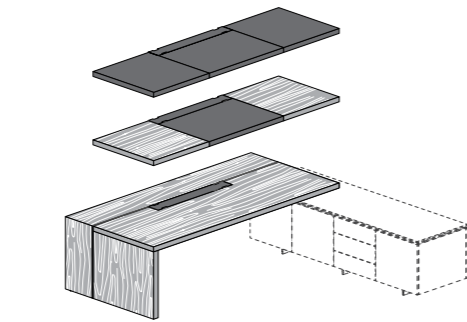
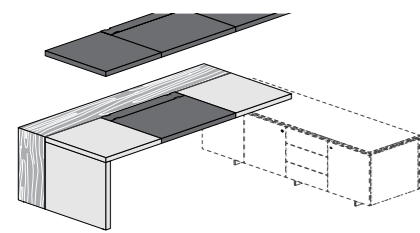

**Tavoli riunione con piano tutto legno**  
Meeting tables with whole veneer top

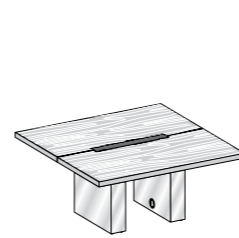

L. 160 P. 160 H. 75

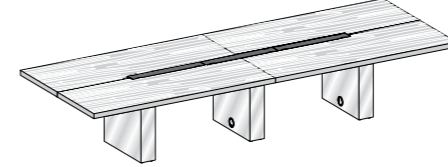
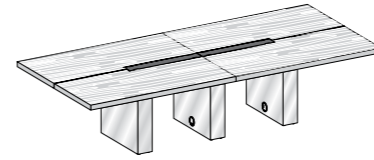

L. 240 P. 140 H. 75

L. 320 - 400 - 480 P. 140 H. 75

**Tavoli riunione con piano in legno/pelle**  
Meeting tables with veneer/leather top

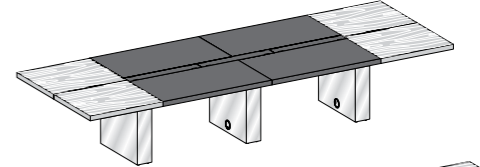
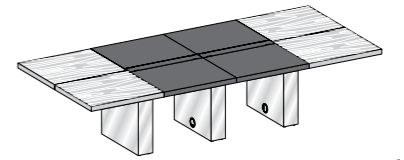

L. 320 - 400 - 480 P. 140 H. 75

**Mobile di servizio per scrivania**  
Side container for desk

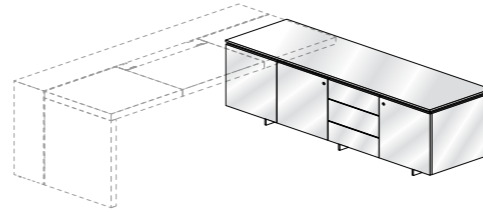

L. 200 P. 60 H. 59

**Mobile di servizio 4 ante**  
Side container with 4 doors

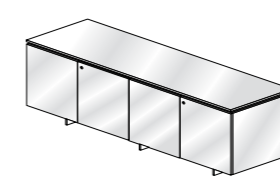

L. 200 P. 60 H. 59

**Appendice frontale**  
Frontal desk appendix

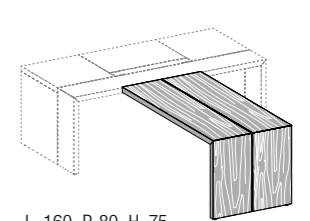

L. 160 P. 80 H. 75

**Cassettiera e Madie**  
Pedestal and Credenzas



L. 41 P. 55 H. 59

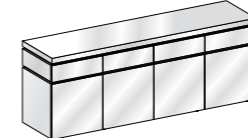

L. 200 P. 50 H. 75

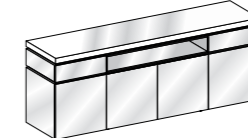

L. 200 P. 50 H. 75

**Consolle**  
Side extension

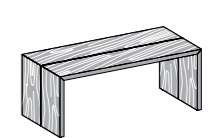

L. 180 P. 60 H. 66

**Librerie**  
Bookcases

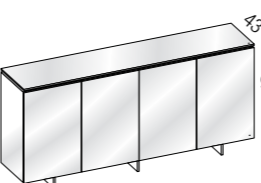

L. 100 - 150 - 200 - 250

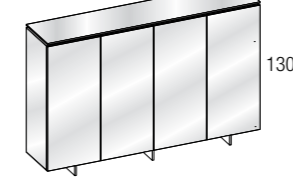

L. 100 - 150 - 200 - 250

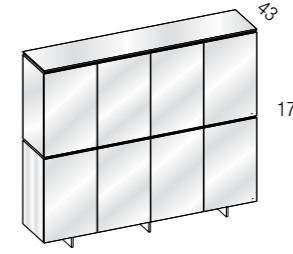

L. 100 - 150 - 200 - 250

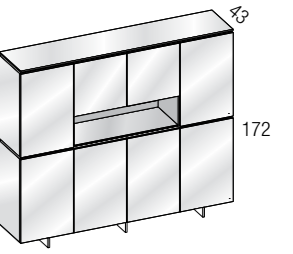

L. 200 - 250 - 300 - 500

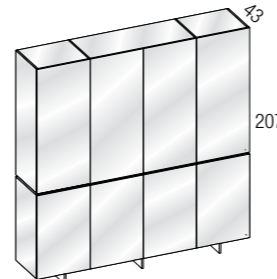

L. 100 - 150 - 200 - 250

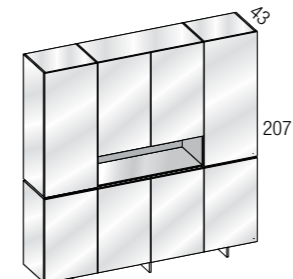

L. 200 - 250 - 300

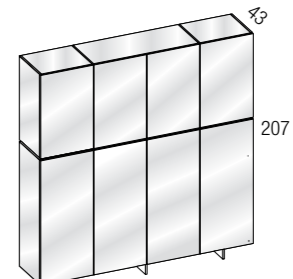

L. 100 - 150 - 200 - 250

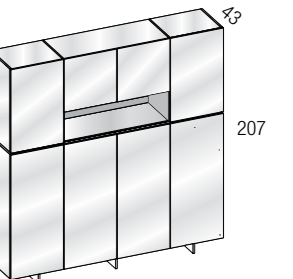

L. 200 - 250 - 300 - 500

art direction, styling and graphics **dogtrot**  
photo **Studio Renai & Renai**  
photo-retouch **Eurografica Verona**  
print **Grafiche Vianello**

si ringrazia:  
**Roberto Raschiotto** scultura pag. 37, 38  
**Lumina** lampade pag. 7, 8, 9, 28, 29, 30, 31  
**Lucente** lampade pag. 50, 52