

# POR TRA ITS

CASAMANIA





**CHAIRS**



**ARMCHAIRS**



**STOOLS**



**UPHOLSTERIES**



**TABLES**



**CAFÉ TABLES**



**COFFEE TABLES**



**ACCESSORIES**



**COAT-RACKS**



**LAMPS**



**BOOKSHELVES AND STORAGE**



**MIRRORS**



**DECORATIVE ITEMS**



**MODULAR SYSTEMS**

**p. 004 CHAIRS AND ARMCHAIRS**  
sedie e poltroncine

Bek  
Stereo  
Stereo metal  
Stereo wood  
Vad  
Vad wood  
Him & Her  
Alieno  
Raphia  
Raphia rocking  
Maritime  
Maritime S  
La-Dina  
Lepel  
Lobby  
Nuance  
Rememberme

**p. 046 STOOLS**  
sgabelli

Kant  
Pressious

**p. 050 UPHOLSTERIES**  
imbottiti

Ben Grimm  
Giro  
Kouch & Ouch  
Morfino  
Pollon  
Radar  
Summit  
Worn

**p. 070 TABLES**  
tavoli

Meduse  
N7  
Pontoon

**p. 078 CAFÉ TABLES**  
tavolini da bar

Rememberme  
T1, T2, T4

**p. 082 COFFEE TABLES**  
favolini da salotto

Elle metal  
Lily  
Meduse  
Twine table

**p. 090 ACCESSORIES**  
accessori

Korzina & Zontik

**p. 092 COAT-RACKS**  
appendiabiti

Alberto  
Hoo  
XX  
Compass

**p. 100 LAMPS**  
lampade

Twee T.  
Granny

**p. 104 BOOKSHELVES AND STORAGE**  
librerie e mobili

Bloom  
Web Stopper  
Alma  
Network  
Robox  
Opus Incertum  
Urban  
Chariot  
Color Fall  
Industry  
Legato  
Toshi  
Valises

**p. 138 MIRRORS**  
specchiere

Rememberme

**p. 140 DECORATIVE ITEMS**  
oggetti decorativi

Maria

**p. 144 MODULAR SYSTEMS**  
sistemi modulari

Festival  
Web system



# BEK

design Giulio Iacchetti  
2007

The strength of the BEK chair stays in the happy marriage between rigidity and lightness, between the important technical solution with injection reinforced with fiberglass and its simple and defined figure. Not only a beautiful and elegant chair but also a folding chair whose slots on the rear supports emphasize the sliding movement of the seat during opening and closing. Manufactured in 2007, it was selected for ADI DESIGN INDEX 2008 and in 2011 it won the Menzione d'onore in the XXII Edition of the Compasso d'Oro award.

## MATERIALS AND FINISHES

Seat and back: reinforced polypropylene with fiberglass.  
Structure: painted metal for outdoor use.

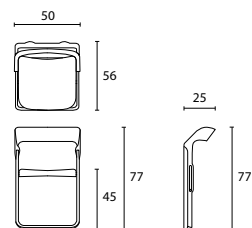

LS43 PS44 HS45



BEK è una seduta la cui forza risiede nel felicissimo matrimonio tra rigidità e leggerezza, tra elevati contenuti tecnici con iniezione rinforzata in fibra di vetro e linee semplici e definite. Una sedia bella, pulita ed elegante che, a guardarla bene si scopre essere anche pieghevole, le cui asole sui montanti posteriori sottolineano il movimento di scorrimento del sedile in fase di chiusura/apertura. Realizzata nel 2007 e selezionata nell'ADI DESIGN INDEX 2008, nel 2011 viene premiata con Menzione d'Onore alla XXII Edizione del Premio Compasso d'Oro ADI.

## MATERIALI E FINITURE

Seduta e schienale: polipropilene rinforzato in fibra di vetro.  
Struttura: metallo verniciato per uso all'esterno.

Chair / Sedia



RAL 7021

RAL 9002





# STEREO collection

design Luca Nichetto  
2008

A complete seating system, available in a range of structures with a choice of wood, painted metal or chromed metal base.

An open, versatile design with multiple possibilities for use in different context, Stereo offers a wide range of colours, materials and functions. The polypropylene seat is glossy on the rear and opaque in front, and can be either partially or completely upholstered.

## MATERIALS AND FINISHES

Structure: chromed metal / painted metal for outdoor use.  
Seat: polypropylene.  
Cover: fabric or leather.

## FABRIC-LEATHER / TESSUTO-PELLE p.150-152

Flukso Extrema AU  
Kvadrat Steelcut 2  
Febrik Uniform Melange  
Dani Florida (leather/pelle)

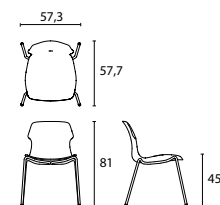

LS45 PS40 HS45

Stackable chair, 4 leg base (Ø 18 cm) with chromed or painted metal in the same colour as the seat with or without under seat cover. Adjustable feet.  
Sedia impilabile a 4 gambe in metallo cromato o verniciato (Ø 18 cm) in tinta con la scocca con o senza cuffia. Piedini autolivellanti.



**1** Structure, under-seat cover, seat cover.  
Struttura, scocca, cuffia.



**2** The structure insert on the underside of the seat  
Innesto della struttura sulla scocca.



**3** Installation of the seat cover.  
Applicazione cuffia.



Sistema di sedute disponibili con diversi tipi di strutture in legno, metallo verniciato (in tinta con la scocca) o cromato. Un progetto aperto, versatile, con molteplici possibilità d'uso e di collocazione. Stereo offre la scelta di diverse combinazioni cromatiche, materiche e funzionali. La scocca in polipropilene, lucida nella parte posteriore e opaca nella parte anteriore, può essere imbottita e rivestita sia totalmente che parzialmente.

## MATERIALI E FINITURE

Struttura: metallo cromato / metallo verniciato per uso all'esterno.  
Scocca: polipropilene.  
Rivestimento: tessuto o pelle.





# STEREO METAL stereo collection



design Luca Nichetto  
2015

The painted metal structure matches the seat colour and completes the Stereo and Stereo Wood collection. The polypropylene seat, is glossy on the back and matte in the front. Stereo Metal can be either partially or completely covered and upholstered. A padded and removable cover has been added to give to Stereo a feminine and domestic appearance.

## MATERIALS AND FINISHES

Structure: painted metal for outdoor use.  
Seat: Polypropylene.  
Cover: Fabric or leather.

## FABRIC-LEATHER / TESSUTO-PELLE p.150-152

Flukso Extrema AU  
Kvadrat Steelcut 2  
Febrik Uniform Melange  
Dani Florida (leather/pelle)

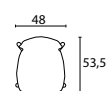

LS45 PS40 HS45

La struttura in metallo verniciato in tinta con la scocca completa la famiglia Stereo e Stereo Wood. La scocca in polipropilene, è lucida nella parte posteriore e opaca nella parte anteriore. Può essere imbottita e rivestita sia parzialmente che totalmente. Per dare un aspetto più domestico e femminile alla sedia è stato pensato un rivestimento leggermente imbottito e sfoderabile.

## MATERIALI E FINITURE

Struttura: metallo verniciato per uso all'esterno.  
Scocca: polipropilene.  
Rivestimento: tessuto, pelle.





# STEREO WOOD stereo collection



design Luca Nichetto  
2011

The structure in natural or painted oak gives a sense of warmth and comfort to the chair.  
The polypropylene seat, is glossy on the back and matte in the front. Stereo Wood can be either partially or completely covered and upholstered.  
A padded and removable cover has been added to give to Stereo a feminine and domestic appearance.

## MATERIALS AND FINISHES

Structure: natural solid oak or walnut painted oak.  
Seat: polypropylene.  
Cover: fabric or leather.  
Removable cover: Plot (Kvadrat) or cotton fabric (Arvex Pandora).

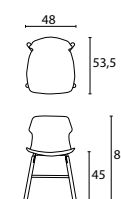

LS45 PS40 HS45

Polypropylene seat / Scocca in polipropilene



RAL9002 Pantone 415C RAL7021 RAL6034 RAL1019 Pantone 174C

Cover and upholstered seat / Scocca rivestita



Removable cover (some examples Kvadrat Plot and Arvex Pandora)  
Rivestimento sfoderabile (alcuni esempi Kvadrat Plot e Arvex Pandora)



La struttura in rovere naturale o tinto noce conferisce alla seduta un aspetto più caldo e confortevole rispetto a tutta la collezione.  
La scocca in polipropilene, è lucida nella parte posteriore e opaca nella parte anteriore. Può essere imbottita e rivestita sia parzialmente che totalmente.  
Per dare un aspetto più domestico e femminile alla sedia è stato pensato un rivestimento leggermente imbottito e sfoderabile.

## MATERIALI E FINITURE

Struttura: legno massello rovere naturale o tinto noce.  
Scocca: polipropilene.  
Rivestimento: tessuto o pelle.  
Rivestimento sfoderabile: tessuto Plot (Kvadrat) o cotone (Arvex Pandora).

## FABRIC-LEATHER / TESSUTO-PELLE p.150-152

Flukso Extrema AU  
Kvadrat Steelcut 2  
Febrik Uniform Melange  
Dani Florida (leather/pelle)

Arvex Pandora p.153  
Kvadrat Plot





# VAD collection



design Luca Nichetto  
2009

A complete seating system available in a range of structures with a choice of wood, chromed or painted (in the same colours of the seat) metal or steel base. The Vad pays a tribute to the tradition of the Scandinavian masters. The body of the chair, durable and striking, is produced in recyclable reinforced polypropylene by means of injection moulding in a single block. Also available with swivel base, the Vad chair offers stackability and is suited indoor as well as outdoor spaces, making it a fit for both contract and domestic environments. The seat is available also with fabric, leather or full-grain hide.

## MATERIALS AND FINISHES

Structure: chromed or painted metal or steel for outdoor use.  
Seat: polypropylene.  
Cover: fabric, leather or full-grain hide.

## FABRIC-LEATHER / TESSUTO-PELLE p.150-152

Flukso Extrema AU, Kvadrat Steelcut 2  
Febrik Uniform Melange, Dani Florida (leather/pelle)

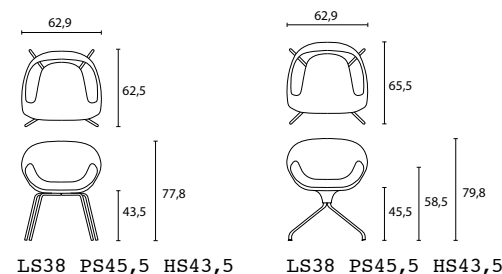

Stackable chair 4 leg base in painted metal in the same colours as the seat.  
Sedia impilabile a 4 gambe in metallo verniciato in tinta con la scocca.



Stackable chair 4 leg base in chromed metal.  
Sedia impilabile a 4 gambe in metallo cromato.



RAL9002 RAL7021 RAL1019 RAL6013



RAL9002 RAL7021 RAL1019 RAL6013

Stackable chair 4 leg base with covered and upholstered seat in fabric or leather.  
Sedia impilabile a 4 gambe con scocca imbottita e rivestita in tessuto o pelle.



Swivel chair with chromed or black painted metal structure.  
Sedia girevole in metallo cromato o verniciato nero.



RAL9002 RAL7021 RAL7021









# VAD WOOD vad collection

design Luca Nichetto  
2011

The structure in natural or painted oak legs adds a sense of elegance and refinement which adheres to the Scandinavian inspired aesthetics of the original VAD chair.

La struttura in rovere naturale o tinto noce rende la seduta più elegante e ricercata mantenendo il gusto tipico della tradizione scandinava.

## MATERIALS AND FINISHES

Structure: natural solid oak or walnut painted oak.  
Seat: polypropylene.  
Cover: fabric, leather or full-grain hide.

## MATERIALI E FINITURE

Struttura: legno massello rovere naturale o tinto noce.  
Scocca: polipropilene.  
Rivestimento: tessuto, pelle o cuoio "a pieno fiore".

## FABRIC-LEATHER / TESSUTO-PELLE p.150-152

Flukso Extrema AU  
Kvadrat Steelcut 2  
Febrik Uniform Melange  
Dani Florida (leather/pelle)

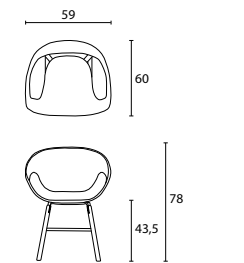

LS38 PS45,5 HS43,5

Polypropylene seat / Scocca in polipropilene 



Covered seat / Scocca rivestita 





# HIM & HER

design **Fabio Novembre**  
2008

Chairs crafted from rotationally moulded polyethylene. Their shapes were created using a 3 dimensional scan of 2 plaster sculptures. Available in two different finishes: matt polyethylene, mass-dyed rotation molded and in polished polyethylene.

## MATERIALS AND FINISHES

Matt or polished polyethylene.

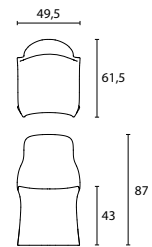

LS38 PS45,5 HS43,5

HIM&HER matt polyethylene /  
HIM&HER polietilene opaco



RAL9003 RAL9004 Hunter green Corten colour

HIM&HER polished polyethylene /  
HIM&HER polietilene verniciato lucido



RAL9003 RAL9004 + colors on request  
+ colori su richiesta

Sedute in polietilene realizzate mediante stampaggio rotazionale. La loro forma deriva dalla scansione tridimensionale di due sculture in gesso. Disponibili in due finiture: polietilene opaco tinto in massa o polietilene verniciato lucido. La versione base, in polietilene opaco, può essere utilizzata anche all'esterno.

## MATERIALI E FINITURE

Polietilene opaco o verniciato lucido.









# ALIENO alieno collection



design GamFratesi  
2009/2015

A complete seating system available in painted metal suitable for outdoor use. Available in 3 versions: with a standard or slender tall back rest suitable for use around a table and a wider, lower 'lounge' version. The term "Alien" comes from the Latin "alius" meaning "other" - the meaning of the word relies on the idea of contrast. It is interesting to give a friendly shape to this 'otherness', it is an appealing thought to accept the "other" or "alien". The simplicity of the shape, is with its immediate and memorable impact belies the designers' desire to offer the user new and fantastic experiences and stories.

Sistema di sedute in tondino di metallo verniciato per l'esterno disponibile in tre versioni: con lo schienale basso e con lo schienale stretto ed alto, adatta all'uso intorno ad un tavolo ed una "lounge", più bassa, larga ed accogliente. Il vocabolo "alieno" deriva da "alius" che significa "altro". L'accezione della parola dipende però dal contesto a cui fa riferimento. Interessante è riuscire a dare un risvolto amichevole a questa polisemanticità, invitando ad accogliere "l'altro" e quindi "l'alieno". La semplicità di queste forme le rende immediatamente riconoscibili e comprensibili trasmettendo a ciascuno nuove storie dai connotati fantastici e immaginari.

## MATERIALS AND FINISHES

Embossed painted metal for outdoor use.

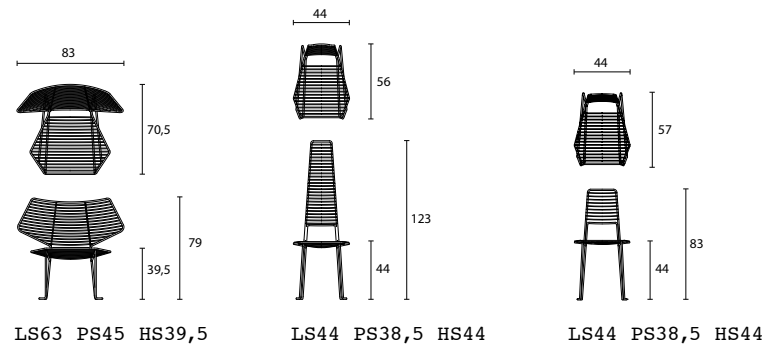

chair / sedia



chair / sedia



armchair / poltroncina



## MATERIALI E FINITURE

Metallo verniciato goffrato per uso all'esterno.



\* cushion is available for the seat  
È disponibile un cuscino per la seduta





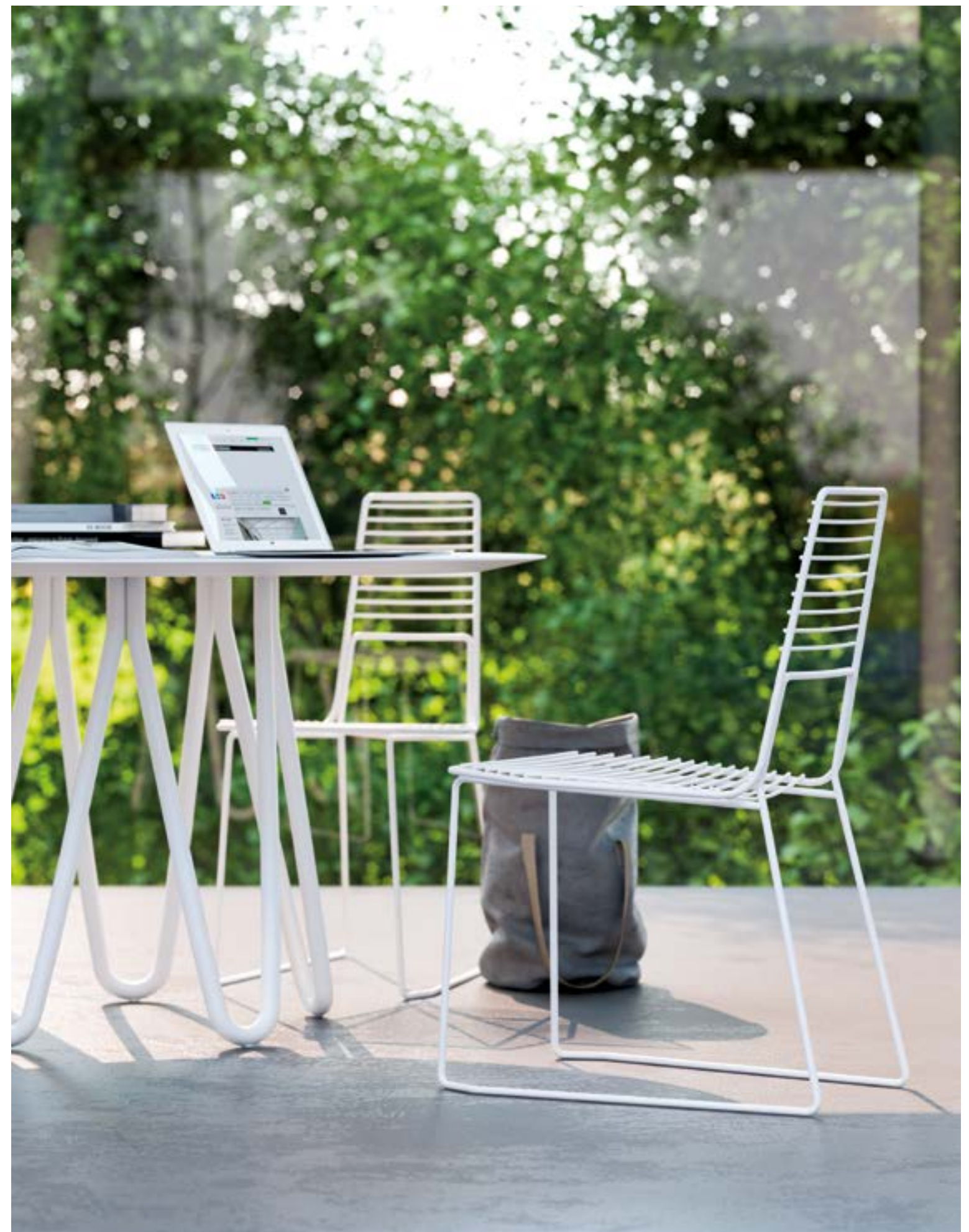



# RAPHIA collection

design **LucidiPevere**  
2013

Raphia is the offspring of a research project into the use of materials and how they can be exploited as furnishings. It is the perfect convergence of modernity and tradition, of technology and craftsmanship. An oxymoron that brings together two of the spirits of production in Italy: the metal industry and the small timehonoured manufacturers of rattan and wicker products. The aim of the project is to lend a certain continuity to the tradition of crafting with rattan, one that stretches back to the beginning of the last century when the areas specialising in this craft saw schools and a culture revolving around this material thrive. Today, there remain very few firms which conserve the know-how of this trade, where manual skills and craftsmanship combine to insure that every creation is unique. Raphia embodies this history and tradition in a contemporary context, thanks to a harmonious balance between two materials: the metal structure is the base upon which the wicker and rattan are weaved to create the seating area.

## MATERIALS AND FINISHES

Structure: embossed painted metal.  
Seat and back: natural rattan or painted fumè wicker.



Suitable for indoor, for protected outdoor areas or for verandas.  
Prodotto per interno, esterno coperto, verande.

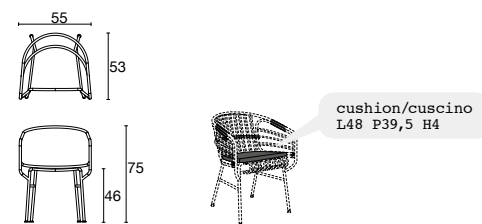

LS42 PS39 HS46

\* A cushion is available for the seat p.153  
É disponibile un cuscino per la seduta p.153



RAL9002 RAL7021 RAL3004 Hunter green Hunter green

Nata dalla ricerca progettuale sull'utilizzo dei materiali e sulle relative applicazioni all'arredo, Raphia è il connubio tra la contemporaneità e la tradizione, tra la tecnologia e l'artigianalità. Un ossimoro che mette insieme due anime della produzione legata alla territorialità italiana: l'industria del metallo e le piccole, storiche, realtà manifatturiere del rattan e midollino. L'intento progettuale è quello di dare continuità alla tradizione della lavorazione del rattan e midollino, una storia dell'inizio del secolo scorso quando attorno alle aree di questi distretti nascevano le scuole e si sedimentava una cultura legata a questo materiale. Oggi esistono ancora poche realtà che conservano i saperi di questa tradizione, dove la manualità e l'artigianalità di ogni pezzo lo rendono unico. Raphia porta con sé questa storia e tradizione in un contesto contemporaneo, attraverso un progetto di equilibrio tra il metallo nella struttura giunco e midollino nella sedia.

## MATERIALI E FINITURE

Struttura: metallo verniciato goffrato.  
Seduta e schienale: giunco naturale e midollino tinto fumè.





# RAPHIA rocking raphia collection



design LucidiPevere  
2014

Raphia Rocking is an extension of the Raphia project, the rattan and metal chair was originally designed by Lucidi Pevere in 2013 for Casamania.

The main feature of the collection is the combination of artisanal craft and industrial production, natural materials and metal. The rocking version incorporates many aesthetic codes of the chair such as the painted metal structure in contrast with the manual processing of the rattan; profile, curves and straight sections of the structure.

At the same time, Raphia Rocking chair has distinctive traits in which the chair arises exclusively for relaxation and relieve, sleek and cozy, thanks to its lumbar pillow.

## MATERIALS AND FINISHES

Structure: embossed painted metal.

Seat and back: natural rattan or painted fumè wicker.



Suitable for indoor, for protected outdoor areas or for verandes.

Prodotto per interno, esterno coperto, verande.

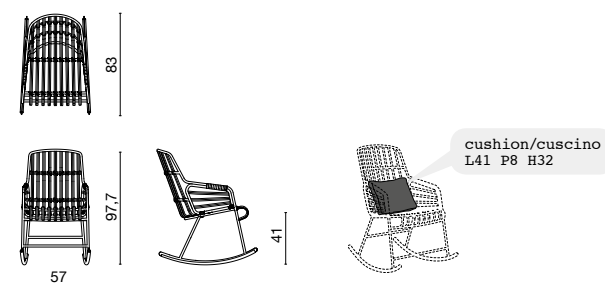

LS55 PS49 HS41

\* A cushion (Febrik-Razzle Razzle) is available for the seat p.155  
È disponibile un cuscino (Razzle Razzle di Febrik) per la seduta p.155

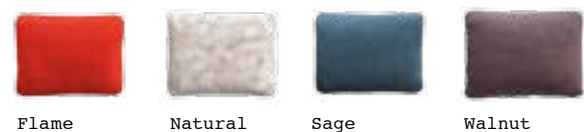

Raphia Rocking è un'estensione del progetto Raphia, la sedia in giunco e metallo disegnata da LucidiPevere nel 2013 per Casamania.

La caratteristica principale della collezione è il connubio tra artigianato e produzione industriale, tra materiali naturali e metallo.

La versione a dondolo riprende molti codici estetici della sedia: ripropone la struttura in metallo verniciato in contrasto con la lavorazione manuale del giunco; il profilo, le curve e i tratti rettilinei della struttura, così come la disposizione del giunco si ispirano al progetto originale.

Allo stesso tempo, Raphia Rocking ha dei tratti propri e distintivi: è una seduta che nasce esclusivamente per il relax e il riposo, sinuosa e accogliente, grazie al cuscino lombare di cui è dotata.

## MATERIALI E FINITURE

Struttura: metallo verniciato gofrato.

Seduta e schienale: giunco naturale e midollino tinto fumè.





# MARITIME & MARITIME S

design Benjamin Hubert  
2011/2012



Maritime is inspired by the maritime world. An elegant and refined chair carefully constructed from solid timber. The precise and refined balance between the structure and the surfaces, assembled by hand using precision crafted pieces add to the value of Maritime. The curved surfaces follow the grain of the timber adding softness and sinuosity to the solid oak structure. Maritime S is the new version of Maritime, enriched with a thin padding, which -included in the wood structure- gives the seat comfort and customizability.

Avvolta da una suggestione che deriva dal mondo marittimo e navale emerge Maritime, una seduta che deve alla classe del design e all'accurata lavorazione artigianale del massello tutta la sua eleganza e raffinatezza. Il preciso e ricercato equilibrio tra la struttura e la scocca, l'assemblaggio manuale delle parti. La ricercatezza e la precisione delle forme costituiscono il vero e proprio valore aggiunto di Maritime. La curvatura della scocca che segue le venature del legno aggiunge morbidezza e sinuosità alla solida struttura in rovere massello. Maritime S è la nuova versione di Maritime, arricchita di una sottile imbottitura che, inserita nella struttura in legno, conferisce alla seduta maggiore comfort e possibilità di personalizzazione.

## MATERIALS AND FINISHES

Maritime: solid and plywood oak.  
Maritime S: solid and plywood oak, fabric or leather upholstery.

## MATERIALI E FINITURE

Maritime: rovere massello e multistrato.  
Maritime S: rovere massello e multistrato, imbottitura tessuto o pelle.

## FABRIC-LEATHER / TESSUTO-PELLE p.150-152

Flukso Extrema AU  
Steelcut 2  
Febrik Uniform Melange  
Dani Florida (leather/pelle)

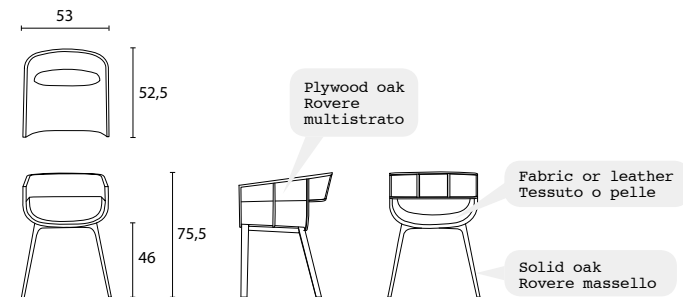

LS40 PS38 HS46

## MARITIME painted plywood oak / rovere multistrato verniciato



## MARITIME S

(some fabric or leather matches / alcuni abbinamenti di pelle o tessuto)





# LA-DINA

design Luca Nichetto  
2014

La Dina, solid ash wood chair, designed by Luca Nichetto for Casamania, is the contemporary reinterpretation of tyrolean chairs, classic icon of a mountain room. Its name plays with that of ladin language, spoken by populations which, in the past, built their settlements in the Dolomites mountains. La Dina uses an easy and solid assembly system, where the legs are engaged in the solid of the seat, which is then secured the backrest thanks to lo schienale grazie a a locking wedge, applied by pressure. The rounded lines and the different colors of the wood make it an elegant chair, ironic and suitable with different domestic places.

## MATERIALS AND FINISHES

Natural or paint solid ash.

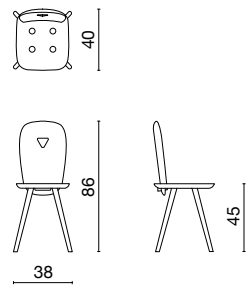

RAL9011 RAL6000 RAL7037

La-Dina, la sedia in legno massello di frassino disegnata da Luca Nichetto per Casamania, è la reinterpretazione in chiave contemporanea delle sedie tirolesi, icona classica nell'immaginario di un ambiente montano. Il suo nome gioca con quello della lingua ladina, parlata dalle popolazioni che, in passato, costruirono i propri insediamenti sui monti Dolomiti. La-Dina utilizza un sistema di assemblaggio semplice e solido, in cui le gambe vengono innestate nel massello della seduta, alla quale viene poi assicurato lo schienale grazie a un cuneo di bloccaggio, applicato a pressione. Le linee arrotondate e le diverse colorazioni del legno la rendono una sedia elegante, ironica e adatta a differenti ambienti domestici.

## MATERIALI E FINITURE

Frassino massello naturale o tinto.

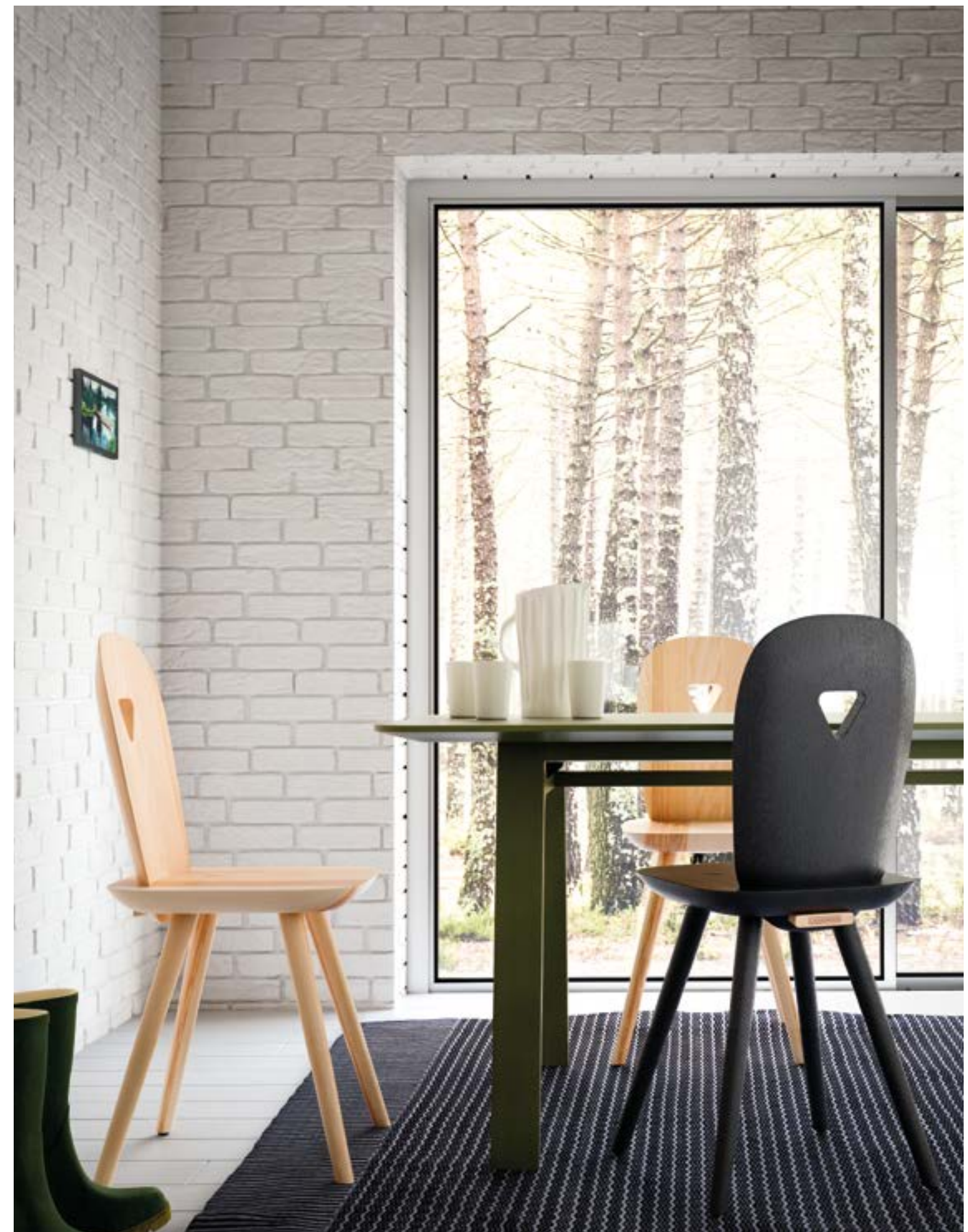



# LEPEL

design Luca Nichetto  
2012



Lepel is a collection of padded chairs, fully upholstered in fabric or leather. The craftsmanship and the ability to customize the finish -from the fabrics used, the stitching at sight- makes this chair unique of its kind. Two different backrests for a single chair.

Chair and armchair, both upholstered and covered with fabric, have the same aesthetic philosophy, optimizing the production of molds.

"Lepel" means "spoon" in Afrikaans: this is the function of the two backrests, to contain and to support the seat like a spoon.

The choice of this name is not accidental: the design studio of Luca Nichetto continues to push for a cultural melting pot with a team more and more international; Sweden, Italy, South Africa, Germany, France, England and the rest of the world were, are and will be part of this team, physically halfway between Venice and Stockholm.

Lepel è una sistema di sedute imbottite, interamente rivestite in tessuto o in pelle. La lavorazione artigianale e la possibilità di personalizzare le finiture -dai tessuti impiegati, alle cuciture a vista- rende questa seduta unica nel suo genere. Due diversi schienali per un'unica seduta. Sedia e poltroncina, entrambe imbottite e rivestite in tessuto, hanno la stessa filosofia estetica, ottimizzando la produzione degli stampi.

Lepel, in Afrikaans vuol dire cucchiaio: è proprio questa la funzione dei due schienali, contenere e sostenere la seduta come un cucchiaio. La scelta di questo nome non è casuale: lo studio di Luca Nichetto continua la sua spinta verso il melting pot culturale con un team sempre più internazionale, Svedesi, Italiani, Sud Africani, Tedeschi, Francesi, Inglese a metà tra Venezia e Stoccolma.

## MATERIALS AND FINISHES

Upholstered: fire resistant cold formed foam  
Internal structure: metal.  
Cover: fabric or leather not removable.

## MATERIALI E FINITURE

Imbottitura: espanso schiumato a freddo ignifugo  
Struttura interna: metallo.  
Rivestimento: tessuto o pelle non sfoderabili.

## FABRIC-LEATHER / TESSUTO-PELLE p.150-152

Flukso Extrema AU  
Kvadrat Steelcut 2  
Kvadrat Divina Melange  
Dani Florida (leather/pelle)

Using these fabrics and leather the seams match the colour.  
Con questi tessuti e pelle la cucitura è sempre in tinta.

Realizable with fabrics or leather in collection, provided by customer (to test) or selected by the designer (see scheme pag. 37).  
Realizzabile con: tessuti e pelli di serie, del cliente (da testare) o scelti dal designer (vedi schema pag. 37).

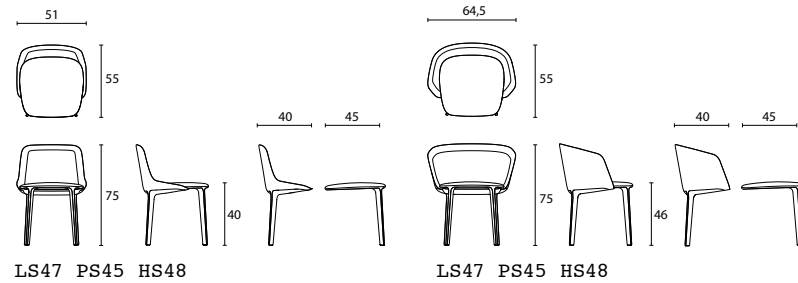

Chair / Sedia (some examples / alcuni esempi)











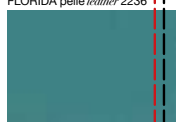

Armchair / Poltroncina (some examples / alcuni esempi)

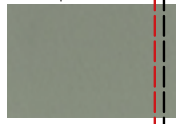



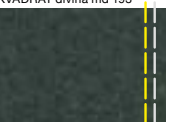
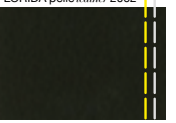
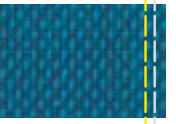

Fabric or leathers selected by the designer / Tessuti e pelli scelti dal designer

<p><b>A</b></p> <p>FLORIDA pelle leather 2236</p>  <p>KVADRAT willow 712</p>  <p>KVADRAT willow 152</p>  <p>FLORIDA pelle leather 2128</p> 	<p><b>A1</b></p> <p>KVADRAT ripple 101*</p>  <p>INNOFA dot grey</p> 	<p><b>B</b></p> <p>KVADRAT willow 542</p>  <p>STEELCUT 2 445</p> 	<p><b>C</b></p> <p>KVADRAT divina md 973</p>  <p>KVADRAT divina md 193</p>  <p>FLORIDA pelle leather 2062</p>  <p>STEELCUT trio 2 865</p> 	<p><b>C1</b></p> <p>INNOFA dotted prune*</p> 
<p>cucitura rossa / nera red / black seam</p>	<p>cucitura rossa / nera red / black seam</p> <p>no trapunta no quilting</p>	<p>cucitura nera black seam</p>	<p>cucitura gialla / bianca yellow / white seam</p>	<p>cucitura gialla / bianca yellow / white seam</p> <p>no trapunta no quilting</p>

Available combinations of fabrics and seams  
Abbinamenti possibili tra tessuti e cuciture

- A+A**    --- cucitura rossa o nera  
              --- red or black seam
- A+A1**    --- cucitura rossa o nera  
              --- red or black seam
- A1+A**    --- cucitura rossa o nera  
              --- red or black seam
- A+B**      --- cucitura nera  
              --- black seam
- B+A**      --- cucitura nera  
              --- black seam
- A1+B**    --- cucitura nera  
              --- black seam
- B+A1**    --- cucitura nera  
              --- black seam
- B+B**      --- cucitura nera  
              --- black seam
- C+C**      --- cucitura gialla o bianca  
              --- yellow or white seam
- C+C1**    --- cucitura gialla o bianca  
              --- yellow or white seam
- C1+C**    --- cucitura gialla o bianca  
              --- yellow or white seam





# LOBBY

design Stokkeastad  
2009

The armchair, which is available completely upholstered either in fabric or leather, is born from the desire to realize a product that creates a space for itself. The extruded armrests delineate an area into which the user enters when he sits down. The same armrests also offer comfort and an inviting space whilst adding a distinctive character to the chair. The form of the chair is clear and decisive with a strong profile and clean lines while the inside is softer and moulded to accommodate the user.

## MATERIALS AND FINISHES

Upholstered: fire resistant cold formed foam.  
Internal structure: metal.  
Cover: fabric or leather.

## FABRIC-LEATHER / TESSUTO-PELLE p.150-152

Flukso Extrema AU  
Kvadrat Steelcut Trio 2  
Febrik Uniform Melange  
Dani Florida (leather/pelle)

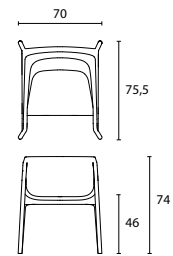

LS44 PS42 HS46

\* Available only for projects, minimum quantity 20 pieces.  
Disponibile solo per progetti, minimo d'ordine 20 pezzi.



La sedia a pozzetto, completamente imbottita e rivestita in tessuto o pelle non sfoderabili, nasce dal tentativo di creare un prodotto che delimiti lo spazio circostante. La particolare forma della seduta e dei braccioli conferisce all'ambiente circostante un'atmosfera familiare ed accogliente. Si tratta di una sedia di carattere, dalle linee pulite, esternamente rigorosa e decisa, internamente modellata e morbida.

## MATERIALI E FINITURE

Imbottitura: espanso schiumato a freddo ignifugo.  
Struttura interna: metallo.  
Rivestimento: tessuto o pelle.

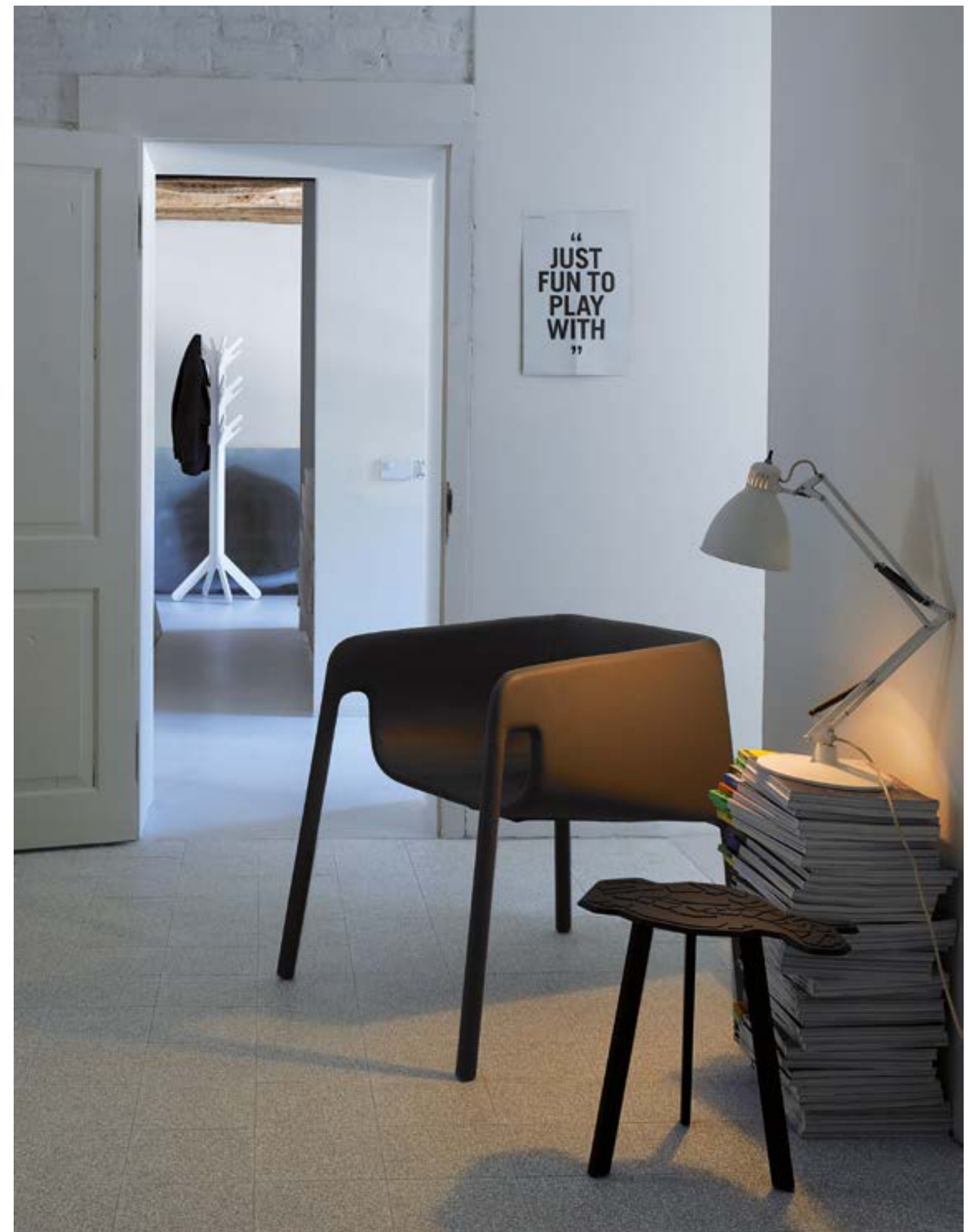



# NUANCE

design Luca Nichetto  
2009

Nuance is a new concept in upholstered seatings. The upholstery of Nuance incorporates a subtle range of colours thanks to the careful workmanship involved in utilising fabric off-cuts. Nuance combines a strong ergonomic approach with visual appeal and the hand-made tradition of the master craftsman, giving extra value to the product as well as minimising waste.

## MATERIALS AND FINISHES

Upholstered: fire resistant cold formed foam.  
Internal structure: metal.  
Cover: solid colour fabric (Gabriel Europost) or multicolor fabric (Kvadrat Tonus 3).

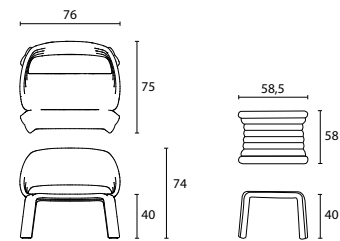

LS60 PS52 HS40

Nuovo concept di seduta imbottita, di poltroncina accogliente con pouf abbinato. Nuance, completamente rivestita ed imbottita è caratterizzata da sfumature di colore ottenute con un fine lavoro di tappezzeria manuale che sfrutta anche gli scampoli di scarto dei tessuti. Nuance quindi coniuga un forte concetto ergonomico e visivo all'etica del lavoro "hand made" che dà valore aggiunto all'oggetto, senza dimenticare l'attenzione alla riduzione degli sprechi.

## MATERIALI E FINITURE

Imbottitura: espanso schiumato a freddo ignifugo.  
Struttura interna: metallo.  
Rivestimento: tessuto tinta unita (Gabriel Europost) o tessuto multicolor (Kvadrat Tonus 3).



Solid colour / Tinta unita (Gabriel Europost) p.155



Multicolor (Kvadrat Tonus) p.154





# REMEMBERME collection



design Tobias Juretzek  
2011

The race towards the future and the desire to keep the past alive coexist in Rememberme. A chair that embodies the current focus on sustainability and recycling Rememberme gives new life to objects which are unconscious memory capsules.

It is made by jeans and cotton t-shirts mixed with a special resin. Rememberme is the beginning of a project with infinite space for development and customization.

## MATERIALS AND FINISHES

Jeans and cotton t-shirts.

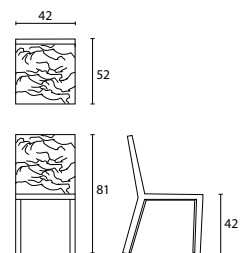

LS42 PS39 HS45



The chair can be customized with jeans and cotton t-shirt provided by the customer.

To produce jeans chair are necessary about 8 pairs of jeans.

To produce jeans + cotton t-shirts are necessary about 4 pairs of jeans + 9 t-shirts for a total of 5 kilos.

La sedia può essere personalizzata con jeans e t-shirt in cotone forniti dal cliente.

Per la sedia solo in jeans sono necessari circa 8 jeans.

Per la sedia jeans + t-shirt in cotone sono necessari circa 4 jeans + 9 magliette in cotone per un totale di 5 kg.

Some chairs examples / Alcuni esempi di sedia

Jeans



Jeans + T-shirt



Lo slancio verso il futuro e la volontà di mantenere vivo il passato convivono in Rememberme. Una seduta che si fa portavoce degli attuali temi sulla sostenibilità e riciclo e mezzo per dare una nuova vita a oggetti che sono inconsapevolmente ma profondamente portatori di ricordi e memorie.

E' realizzata mescolando jeans e t-shirt di cotone con una speciale resina. Rememberme è un progetto che inizia oggi ma che prospetta ampi margini di sviluppo e personalizzazione.

## MATERIALI E FINITURE

Jeans e magliette in cotone.



**1** Jeans + t-shirt are treated With the resin.  
Jeans + t-shirt vengono trattati con la resina.

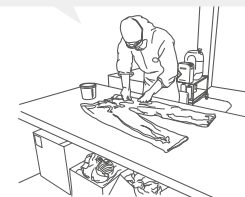

**2** They are inserted into the mould.  
Vengono inseriti nell'apposito stampo.



**3** Jeans + t-shirt and resin are allowed to dry.  
Jeans + t-shirt e resina vengono lasciati asciugare.

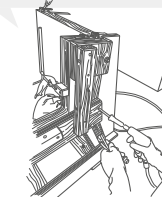

**4** Your chair is ready.  
La tua sedia è pronta.









# KANT

design Karim Rashid  
2006

Kant is the stool inspired by the words of the philosopher, that blurs the lines between art and nature. Produced in recyclable reinforced polypropylene, Kant has a carrying capacity of up to 200 kg/440 lbs. of weight despite its characteristic cantilevered construction. Suitable for indoor and outdoor use, for both domestic and contract environments. In the swivel version with gas lift, the base and the footrest are crafted from die-cast aluminium.

## MATERIALS AND FINISHES

Fixed: polyethylene.  
Swivel with gas lift: polyethylene and aluminium.



fixed / fisso  
swivel with gas lift / girevole con alzata a gas

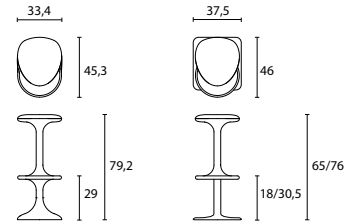

LS30 PS33

Fixed / Fisso



RAL9002

RAL7021

swivel with gas lift / girevole con alzata a gas



RAL9002

RAL7021

RAL1019

1 Reduced packaging for fixed Kant. Imballo ridotto per Kant fisso.

2 Structure, screw, seat. Struttura, vite, seduta.

3 Assembly of structure and screw. Assemblaggio struttura e vite.

4 Place the seat on the structure. Applicazione seduta sulla struttura.

5 Weight up to 200Kg. Peso fino a 200Kg.

6 Correct use of the seat. Uso corretto della seduta.



## MATERIALI E FINITURE

Fisso: polietilene.  
Girevole con alzata a gas: polietilene e alluminio.





## **PRESSIOUS** stool

design Harry&Camila  
2009

Technology and design are the base of the PRESSIOUS chairs. On the one hand, the 3D technology that shapes and bends the body, a single piece of plywood beech, and on the other hand the shape of the legs, sleigh base, in which resides all the creative and artistic strength of the product. Realized in 2009, PRESSIOUS echoes of an elegant and irreverent design.

### **MATERIALS AND FINISHES**

Structure: black painted metal.  
Seat: painted oak or walnut plywood beech.

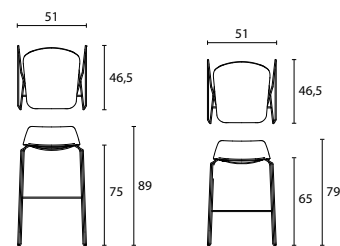

Tecnologia e design sono i due perni attorno a cui è stata realizzata la seduta PRESSIOUS. Da un lato la tecnologia 3D che sagoma e curva la scocca, pezzo unico in multistrato di faggio, e dall'altro la nota distintiva nella forma delle gambe, a slitta, in cui risiede tutta la forza creativa e artistica della seduta. Realizzato nel 2009 dai designer Harry&Camila, PRESSIOUS si fa portavoce di un design di grande eleganza senza rinunciare ad un tocco di irriverenza.

### **MATERIALI E FINITURE**

Struttura: metallo verniciato nero.  
Scocca: legno multistrato di faggio tinto rovere o noce.





# BEN GRIMM

design **Luca Nichetto**  
2007

Seating system which allows to create several shapes simply positioning the various modules side by side and creating quite different situations and atmospheres. Metal supporting structure and elastic belts. High density polyurethane padding. The backrests are modular and can be used on all sides of the seat by means of the underneath positioned runners.

Ideal for community spaces.

## MATERIALS AND FINISHES

Seat structure: plywood and elastic belts.  
Back Structure: metal.  
Upholstered/Padding: high density polyurethane.  
Cover: removable fabric cover.

## FABRIC-LEATHER / TESSUTO-PELLE p.150-152

Flukso Extrema AU  
Kvadrat Steelcut 2  
Febrik Uniform Melange  
Dani Florida (leather/pelle)

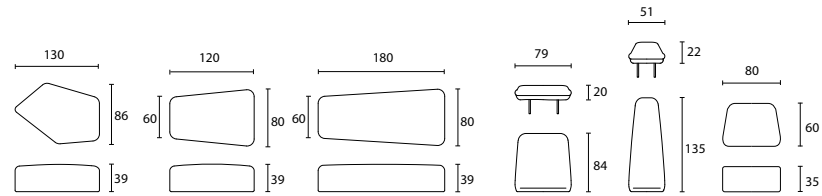

Sistema di sedute che permette di realizzare molteplici configurazioni grazie all'affiancamento dei vari moduli creando situazioni ed atmosfere sempre differenti fra loro. Struttura portante in metallo e cinghie elastiche. Imbottitura in poliuretano ad alta densità. Gli schienali sono modulari e posizionabili su tutti i lati della seduta per mezzo di corsie sottostanti.

Ideale per arredare ambienti e spazi pubblici.

## MATERIALI E FINITURE

Struttura seduta: multistrato di legno e cinghie elastiche.  
Struttura schienale: metallo.  
Imbottitura: Poliuretano ad alta densità.  
Rivestimento: Tessuto o pelle sfoderabili.

\* It is possible to upholster it using client's fabric.  
È possibile rivestire Bengrimm con tessuto cliente.









# GIRO

design Claesson Koivisto Rune  
2013

Giro is a system of ottoman that develop in a series of circular seats. Like a whirlwind unfurling, thanks to the size of its diameter, into a series of three poufs, each one appears diverse from the last depending on your standpoint. Giro takes up the game of hula hoop, its movement; it moves in a three-dimensional space and its colour lends it tone, shading. Available fixed or with a swivel base.

## MATERIALS AND FINISHES

Internal structure: fire resistant expanded foam.  
Upholstery: non-removable fabric or leather.  
Top: natural solid oak.

## FABRIC-LEATHER / TESSUTO-PELLE p.150-152

Flukso Extrema AU  
Kvadrat Steelcut 2  
Febrik Uniform Melange  
Dani Florida (leather/pelle)  
Dani vintage (leather/pelle)

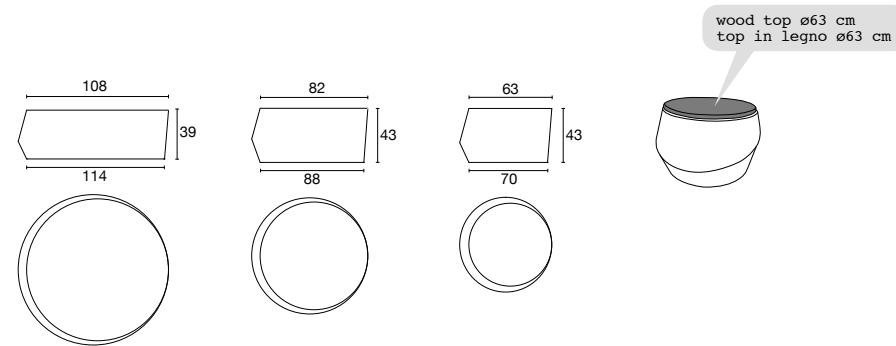

Some examples / Alcuni esempi



Giro è un sistema di pouf che si sviluppa in una serie di sedute a base circolare. Come una torsione del punto che si declina -per dimensione del diametro- in 3 pouf, che a seconda del punto di vista, sembrano diversi l'uno dall'altro. Giro riprende il gioco dell'hula hoop, del suo movimento; si muove nello spazio a tre dimensioni e i colori ne danno il tono, la sfumatura. Disponibile fisso o girevole.

## MATERIALI E FINITURE

Struttura interna: espanso schiumato a freddo ignifugo.  
Rivestimento: tessuto o pelle non sfoderabile.  
Piano: rovere massello naturale.





# KOUCH & OUCH

design Karim Rashid  
2009

A sofa and armchair that embraces and envelops using the iconic forms that Karim has made his personal signature. Sculptural and bright, Kouch adds a sense of monolithic joy to the spaces they adorn. "I have taken a great interest in organic form for the last 20 years. I feel a desirous need to soften the commodity landscape as our lives become more casual and relaxed. I want to be enveloped by my Kouch - Ouch! This casualism of shape, form, material and behavior are definitely a movement. The technology that affords us to morph, undulate, twist, torque, and blend our world is so ever inspiring to me. KOUCH and OUCH are my voluptuous organic and ergonomic blobs to continue my pursuit for this New 'Soft World' language".

## MATERIALS AND FINISHES

Structure: fire resistant cold formed foam.  
Internal structure: metal.  
Upholstery: fabric or leather.

## FABRIC-LEATHER / TESSUTO-PELLE p.150-152

Flukso Extrema Au  
vadrat Steelcut 2  
Febrik Uniform Melange  
Dani Florida (leather/pelle)

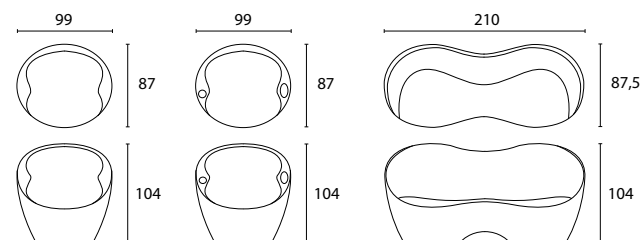

LS50 PS50 HS36

LS108 PS50 HS36

## OUCH some examples / alcuni esempi



## KOUCH some examples / alcuni esempi



Divano a due posti e poltrona dalla forma voluttuosa, organica ed ergonomica. Realizzata in espanso schiumato a freddo ignifugo con struttura interna in metallo e completamente rivestito in tessuto o pelle non sfoderabili. 'È da vent'anni che nutro un grande interesse per le forme organiche. Sento infatti il bisogno di "ammorbidire" i beni che mi circondano per rendere la nostra vita più casual e rilassante. Desidero essere avvolto dal mio Kouch - Ouch! Questo "casualismo" di forme, figure, materiali e comportamenti è in realtà un movimento. Mi ha sempre ispirato la tecnologia che permette di plasmare, ondulare, girare, torcere e fondere il mondo. KOUCH e OUCH sono creazioni voluttuose, organiche ed ergonomiche che esprimono questa mia continua ricerca di un innovativo linguaggio "Mondo Soft".

## MATERIALI E FINITURE

Struttura: espanso schiumato a freddo ignifugo.  
Struttura interna: metallo.  
Rivestimento: tessuto o pelle.





# MORFINO

design C.S.C.  
2005

Lounge chair and ottoman realized in expanded polystyrene balls and covered in leatherette. No rigid or blunt parts. Characterized by a slightly concave design in order to receive and envelop the body. Designed for adults, morfino line is available also for children from 0 to 9. Ideal for living rooms, children's bedrooms or play rooms in domestic or community spaces.

## MATERIALS AND FINISHES

Expanded polystyrene filling and covered in leatherette (SF).

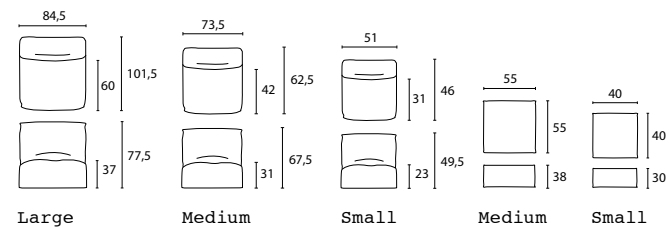

(SF) Leatherette p.156



Colours available also in the fireproof version with 30% surcharge over price list.  
Colori disponibili anche nella versione ignifuga con maggiorazione del 30% rispetto al prezzo di listino.

Large



Small (0-4 anni/years old)



Small (0-4 anni/years old)



Poltroncina e pouf realizzati con palline di polistirene espanso e rivestiti in similpelle. Privi di strutture rigide e parti contundenti. Caratterizzati da un design leggermente concavo per raccogliere ed avvolgere il corpo. Pensata per i grandi la linea morfino è disponibile anche in misure ridotte per i bambini fino ai nove anni. Ideale arredo per zone giorno, camerette o zone gioco in ambienti domestici o spazi comunitari.

## MATERIALI E FINITURE

Polistirene espanso e rivestimento in similpelle (SF).

Medium (4-9 anni/years old)



Medium (4-9 anni/years old)





# POLLON POUF

design C.S.C.  
2005

The pollon ottoman is characterized by a rounded, cylindrical shape. This ottoman is stuffed with expanded polystyrene balls and is covered in fabric or leather and has no rigid or blunt parts. Ideal for internal or external domestic or community spaces.

## MATERIALS AND FINISHES

Filling: expanded polystyrene balls  
cover: leatherette (SF) or plastic self draining fabric (Net Medium NU)  
"Net Medium" (NU) fabric is a high resistance plastic fabric, self draining and easy to clean. Perfect for outdoor use.

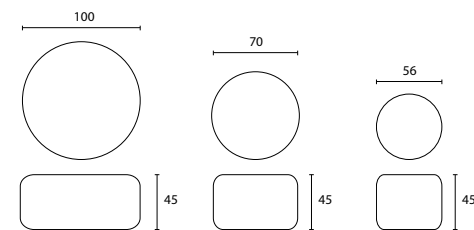

(SF) Leatherette / Similpelle p.156



Colours available also in the fireproof version with 30% surcharge over price list.  
Colori disponibili anche nella versione ignifuga con maggiorazione del 30% rispetto al prezzo di listino.

(NU) Net Medium p.156

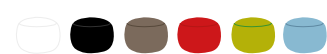

Contrast border / Bordo in contrasto  
white / bianco  
brown / marrone  
black / nero



Ha la forma di un cilindro bombato. Realizzato con palline di polistirene espanso e rivestito in tessuto o pelle è privo di strutture rigide e parti contudenti. Ideale arredo per ambienti domestici o spazi comunitari sia interni che esterni.

## MATERIALI E FINITURE

Imbottitura: polistirene espanso.  
Rivestimento: similpelle (SF) o tessuto plastico drenante (Net Medium NU) e internamente accoppiata ad uno strato di poliuretano espanso.  
Il rivestimento "Net Medium" (NU) è un tessuto plastico dall'elevata resistenza e facilità nella pulizia. Ottima traspirazione. Ideale per un uso all'esterno.

Tessuto drenante "Net Medium. Self-drainig fabric "Net Medium".





# RADAR

design Claesson Koivisto Rune  
2014

The four armchairs Radar, designed by Claesson, Koivisto, Rune for Casamania, have a designed a signature hallmark from which the collection takes its name: the back rest creates an enveloping form of privacy and comfort. Radar is available in four different versions, defined by the volume of the back, which allows for the design to give a contemporary and welcoming spirit. Available with a revolving basis, for a free movement, armchairs Radar fit for both commericla lounges and various sitting areas.

## MATERIALS AND FINISHES

Structure: metal and fire resistant cold formed foam.  
Cover: fabric or leather.  
Fixed or swivel base.  
Seat cushion: removable fabric or leather.

## FABRIC-LEATHER / TESSUTO-PELLE p.150-152

Flukso Extrema Au  
Kvadrat Steelcut 2  
Febrik Uniform Melange  
Dani Florida (leather/pelle)  
Dani Vintage (leather/pelle)

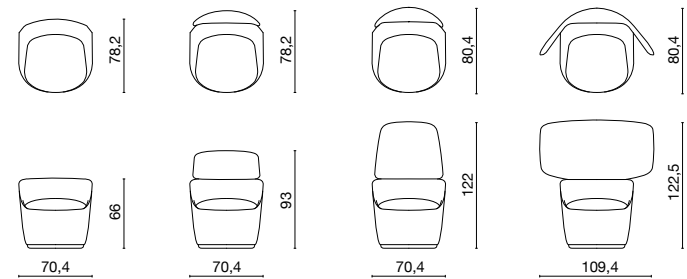

LS59 PS52 HS43



Le quattro poltrone Radar, progettate da Claesson, Koivisto, Rune per Casamania, hanno un segno distintivo da cui prende il nome la stessa collezione: lo schienale dalla forma avvolgente. Radar è disponibile in quattro diverse versioni, definite dai volumi dello schienale, che conferisce alla seduta uno spirito accogliente e contemporaneo. Disponibili con una base girevole, per la libertà di movimento, le poltrone Radar si adattano sia per le sale d'attesa, sia per salotti e ingressi.

## MATERIALI E FINITURE

Struttura: metallo ed espanso schiumato a freddo ignifugo.  
Rivestimento: tessuto o pelle.  
Base girevole o fissa.  
Cuscino seduta: tessuto o pelle sfoderabile.

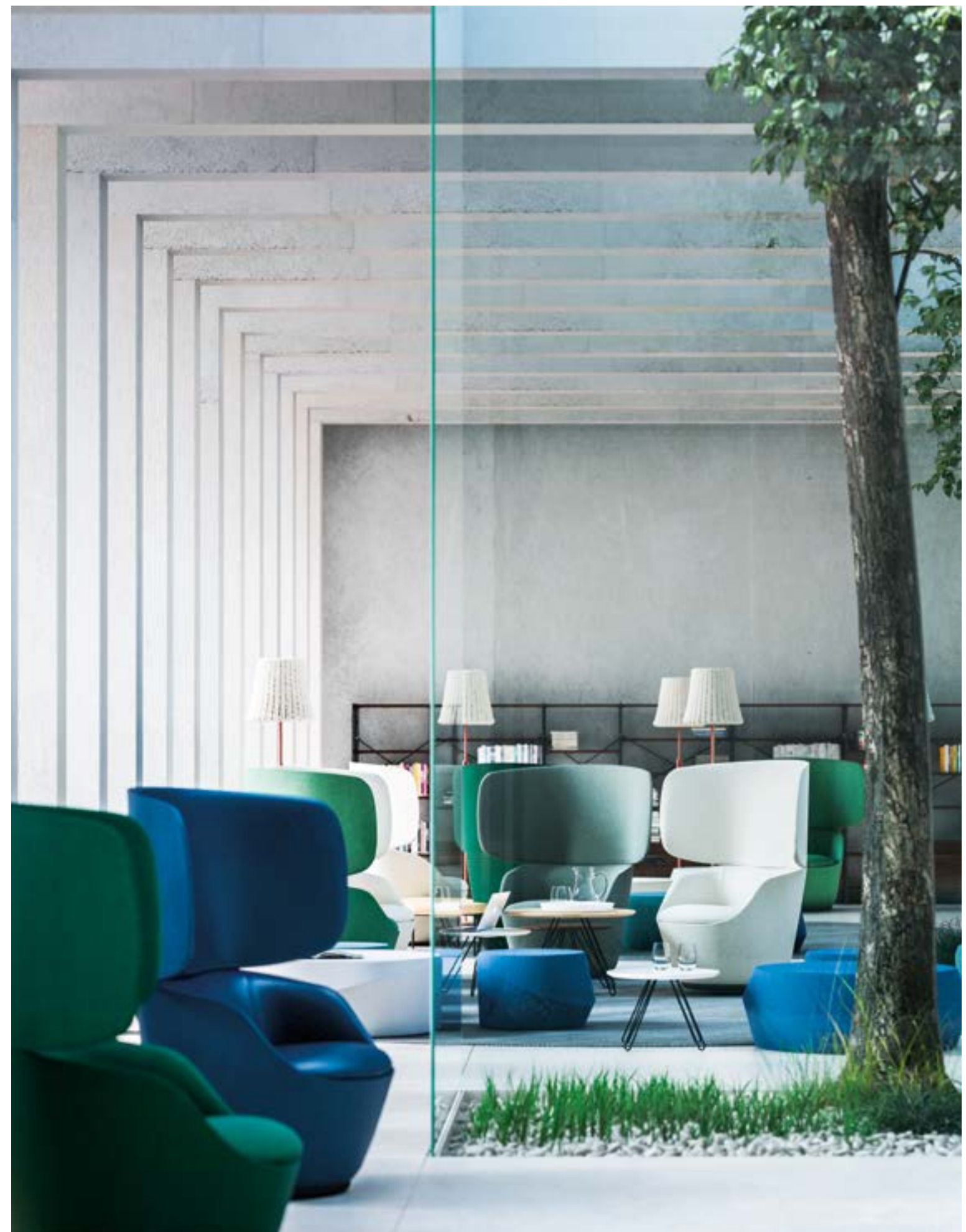



# SUMMIT

design Giulio Iacchetti  
2015

"It can be pronounced as a Latin term or as a English pronunciation (I prefer Latin). Summit is for gathering or meeting; this sofa is perfectly suited for people who want to talk and have a dialogue, looking into each other's eyes while sitting on the same sofa" Giulio Iacchetti.  
It is available in fixed version in four compositions: armchair, 2 seats sofa small, 2 seats sofa, 3 seats sofa. In jointed version there are 2 seats sofa and 3 seats sofa. The modules are linked among themselves thanks to metal joints, that allows the rotation and movement of the sofa. The internal structure is in polyurethane foam the feet are in painted metal. The cover, all removable, is available in fabric or leather.

## MATERIALS AND FINISHES

Feet: black painted metal (RAL 9005).  
Internal structure: metal.  
Padding: differentiated density polyurethane foam.  
Cover: fabric or leather.

## FABRIC-LEATHER / TESSUTO-PELLE p.150-152

Flukso Extrema AU  
Kvadrat Steelcut 2  
Febrik Uniform Melange  
Dani Florida (leather/pelle)

Fixed version / Versione fissa

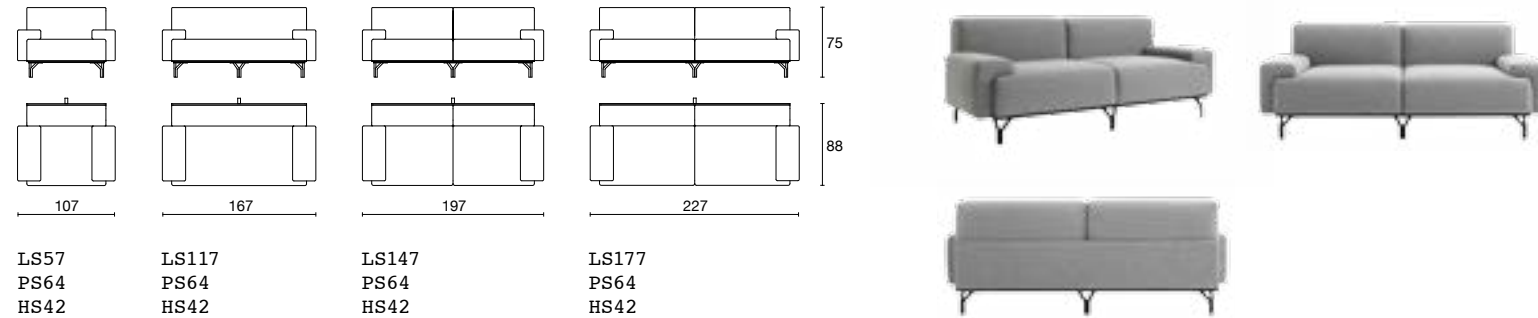

Jointed version / Versione snodabile

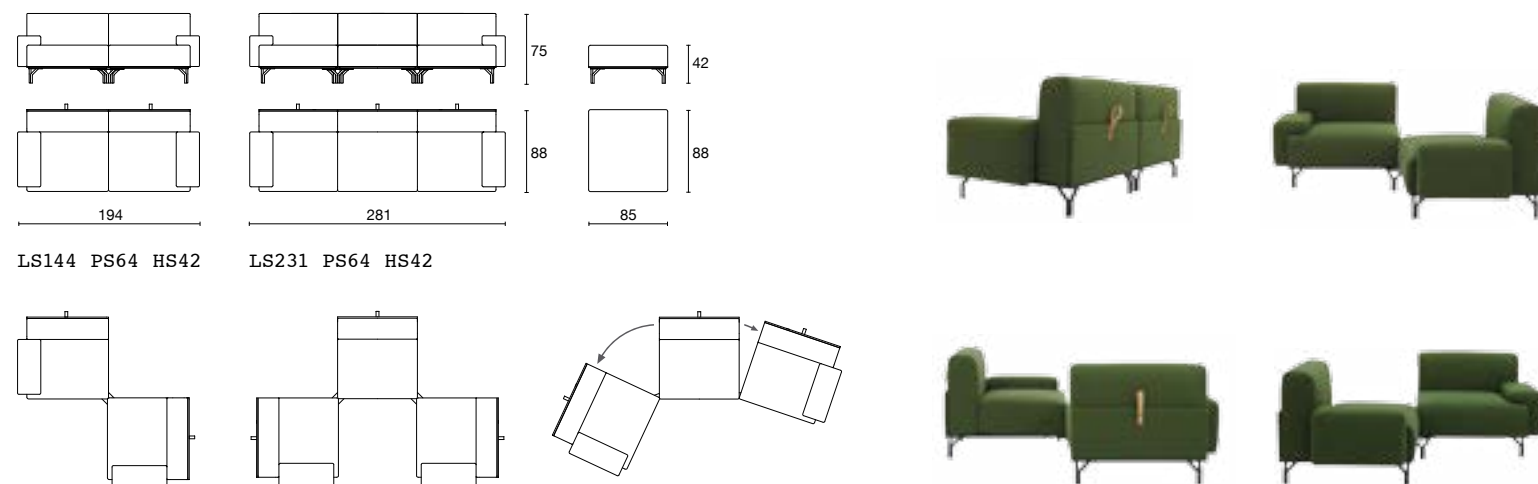

"Si può pronunciare sia come termine latino che con la pronuncia inglese (io preferisco il latino). Summit sta per incontro o meeting e noi sappiamo che questo divano ha una forte vocazione per ospitare le persone che vogliono dialogare e parlarsi guardandosi negli occhi, pur stando sedute sul medesimo divano. Se il divano è piccolo avremo il Mini Summit o, viceversa, il Gran Summit" Giulio Iacchetti.  
È disponibile nella versione fissa in 4 varianti poltrona, divano a due posti small, divano a due posti, divano a tre posti. I moduli sono uniti tra loro attraverso dei piedini snodabili che ne permettono la rotazione e il movimento. La struttura interna è in poliuretano espanso a densità differenziata. I piedini sono in metallo verniciato. Il rivestimento, completamente sfoderabile, è disponibile in tessuto o pelle.

## MATERIALI E FINITURE

Piedini: metallo verniciato nero (RAL 9005).  
Struttura interna: metallo.  
Imbottitura: poliuretano espanso a densità differenziata.  
Rivestimento: tessuto o pelle.

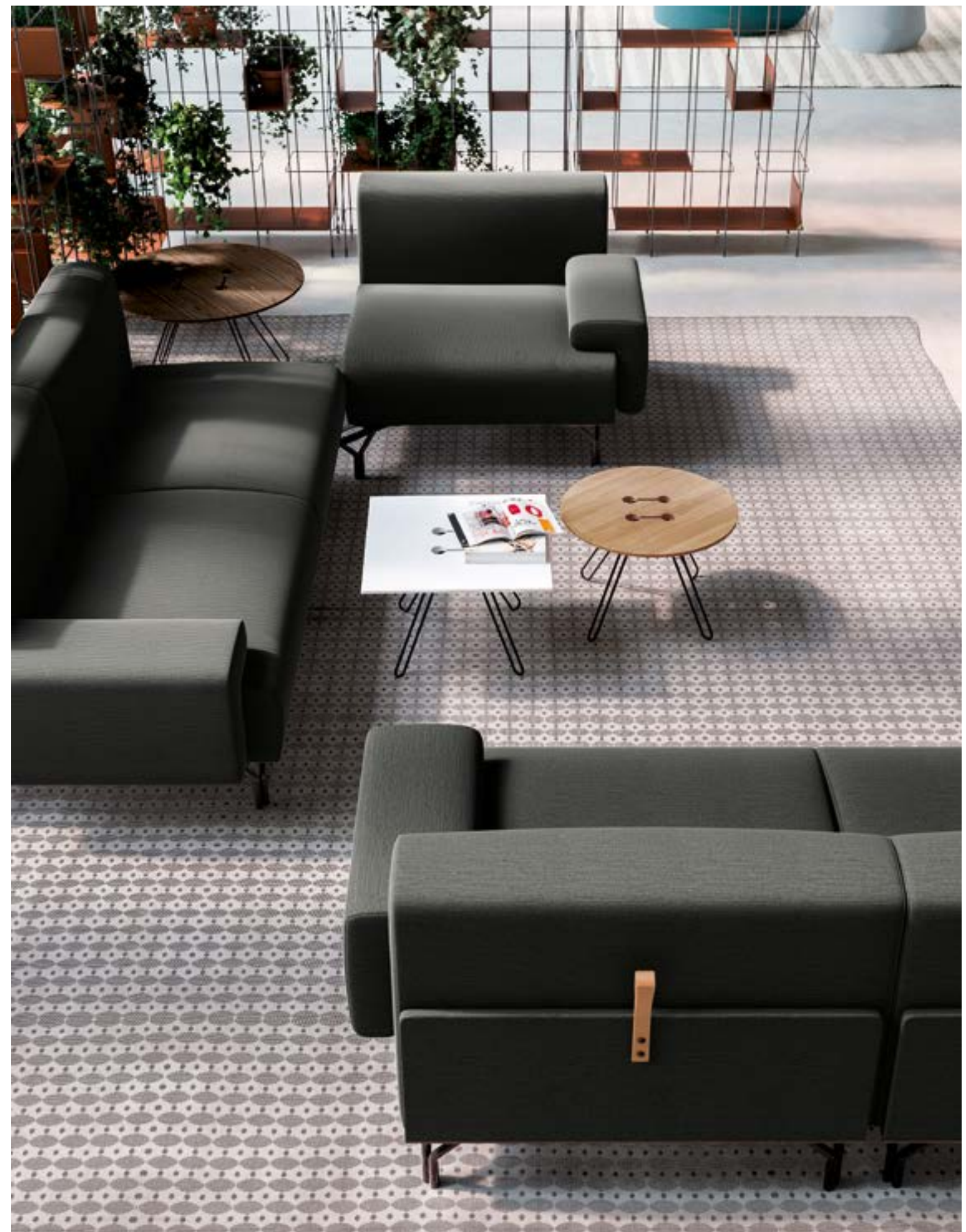







# WORN

design **Samuel Wilkinson**  
2014



The collection of upholstered furniture Worn, designed by Samuel Wilkinson for Casamania, is composed by an armchair, a two and three person seating option. The distinctive detail – a contrasting leather patch that covers the arms – it's strategically positioned on the most rested areas – the arm rest. The natural leather is not treated and, with daily use it will develop a natural patina allowing the seat to age in an elegant manner – each sofa unique to the other. The finish of the leather of the arm is accentuated by a decorative belt that shows the quality and the function of the working of the upholstered. The backrest pillows are made in goose feather making for an incorporation of a comfort collection.

## MATERIALS AND FINISHES

Structure: Metal and elastic belt.  
Back: plywood  
Padding: high density polyurethane.  
Cover: fabric or leather.  
Armrests: always in leather.

## FABRIC-LEATHER / TESSUTO-PELLE p.150-152

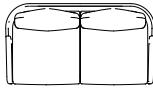
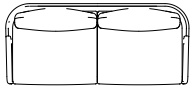
Flukso Extrema Au  
Kvadrat Steelcut 2  
Febrik Uniform Melange  
Dani Florida (leather/pelle)

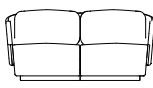
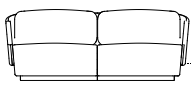
armchair poltrona	2 seats sofa divano 2 posti	3 seats sofa divano 3 posti	
			90
			81
83	167	200	
LS66 PS56/80 HS42	LS152 PS56/80 HS42	LS185 PS56/80 HS42	

\* Armrest in leather Dani Vintage  
Bracciolo in pelle Dani Vintage



La collezione di imbottiti Worn, disegnata da Samuel Wilkinson per Casamania, è composta da una poltrona, un divano a due posti e un divano a tre posti. Il dettaglio distintivo - un contrastante ritaglio di pelle naturale che riveste i braccioli - è strategicamente posizionato sulle zone che normalmente si usano di più. La pelle naturale non è trattata e, con l'utilizzo, svilupperà naturalmente una patina che permetterà alla seduta di invecchiare in modo elegante. La rifinitura della pelle del bracciolo è accentuata da una cucitura decorativa che mostra la qualità e l'abilità della lavorazione degli imbottiti. I cuscini dello schienale in piuma d'oca rendono questa collezione di grande comfort.

## MATERIALI E FINITURE

Struttura portante: metallo e cinghie elastiche.  
Schienale: multistrato di legno.  
Imbottitura: poliuretano ad alta densità.  
Rivestimento: tessuto o pelle.  
Braccioli: sempre in pelle.





# MEDUSE

design GamFratesi  
2009

Round table inspired by the iconic form of the jellyfish ('meduse' in Italian). The structure is in coloured metal and the table top is available in ash or smoked glass.

## MATERIALS AND FINISHES

Structure: painted metal.  
Top: ash or glass.

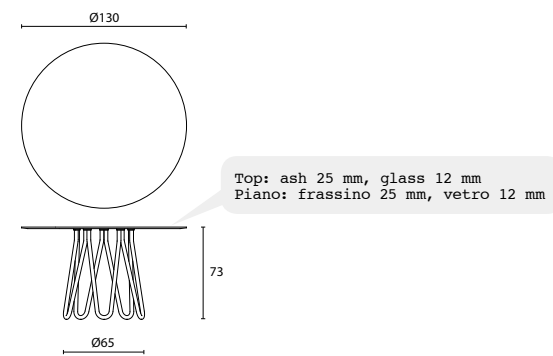

White ash top and structure in white embossed painted metal  
Piano in frassino bianco e struttura in metallo verniciato goffrato bianco



Fumè glass top and structure in black embossed painted metal  
Piano in vetro fumè e struttura in metallo verniciato goffrato nero



Fumè glass top and structure in bronzed painted metal  
Piano in vetro fumè e struttura in metallo verniciato bronzo



 Glass top is packed in a wooden crate  
Il piano in vetro è imballato su cassa di legno

Tavolo rotondo ispirato ad un'iconica forma di medusa.  
Struttura in metallo verniciato e piano disponibile in frassino o in vetro fumé.

## MATERIALI E FINITURE

Struttura: metallo verniciato.  
Piano: frassino o vetro.





# N7

design **Norayr Khachatryan**  
2008

The N7 table, fully made in aluminium, is the result of a close observation of the world: both natural and man made. The Table is a single piece of cast aluminium taking its inspiration from nature in the balance of form and function, and from the man-made world in its appropriation of a stylistic language typically associated with military engineering. Faceted and determined and at the same time functional and elegant. "N7 refers to military and aeronautical iconography. The complexity of the structure, its angular forms, its volumetric details result from a challenging construction closely linked to the use of a specific material (ten bent and welded aluminium sheets) and folding techniques." "Good Design Award 2008" Chicago Athenaeum.

### MATERIALS AND FINISHES

Natural or painted aluminium.

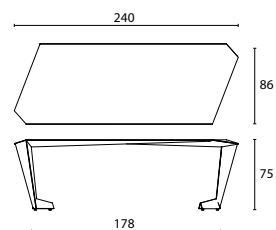

RAL9016



Aluminium



RAL9005



Bronze



The table is packed in a wooden crate.  
Each piece is individually numbered.  
Il tavolo è imballato su cassa di legno.  
Ogni singolo tavolo è numerato.



Il tavolo N7, realizzato interamente in alluminio, è il risultato dell'osservazione attenta del mondo che ci circonda, sia naturale che artificiale. Dalla natura coglie l'equilibrio tra forma e funzione, dal mondo umano il linguaggio stilistico dell'ingegneria militare. Sfaccettato e determinato, N7 è allo stesso tempo funzionale ed elegante. "N7 si ispira principalmente all'iconografia aeronautica militare. La complessità della struttura, le sue forme angolari, i dettagli volumetrici, risultano da una costruzione impegnativa che si focalizza prevalentemente sulla specificità del materiale (dieci fogli di alluminio piegati, saldati) e la tecnica di piegatura." Premio "Good Design Awards 2008" Chicago Athenaeum.

### MATERIALI E FINITURE

Alluminio naturale o verniciato.









# PONTOON

design Benjamin Hubert  
2012

Pontoon is a table with simple and structural lines, made of natural oak. A combination of shapes and materials that gives the product elegance and strength: the geometry and the formal language of Maritime chair, introduced in 2011, is taken again to create a simple and authentic table.

## MATERIALS AND FINISHES

Structure: solid oak.  
Top: natural or painted oak veneered mdf.

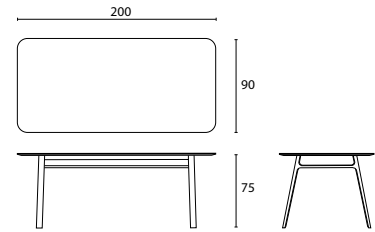

Natural oak  
Rovere naturale



Painted walnut solid oak  
Rovere tinto noce



Painted black solid oak  
Rovere tinto nero



Painted green solid oak  
Rovere tinto verde



Painted grey solid oak  
Rovere tinto grigio

Pontoon è un tavolo dalle linee semplici e strutturali, realizzato in rovere naturale. Un connubio di forme e materiali che dona al prodotto eleganza e solidità: la geometria e il linguaggio formale della seduta Maritime, presentata nel 2011, viene ripresa per creare un tavolo semplice e autentico.

## MATERIALI E FINITURE

Struttura: rovere massello.  
Piano: mdf impiallacciato rovere naturale o tinto.

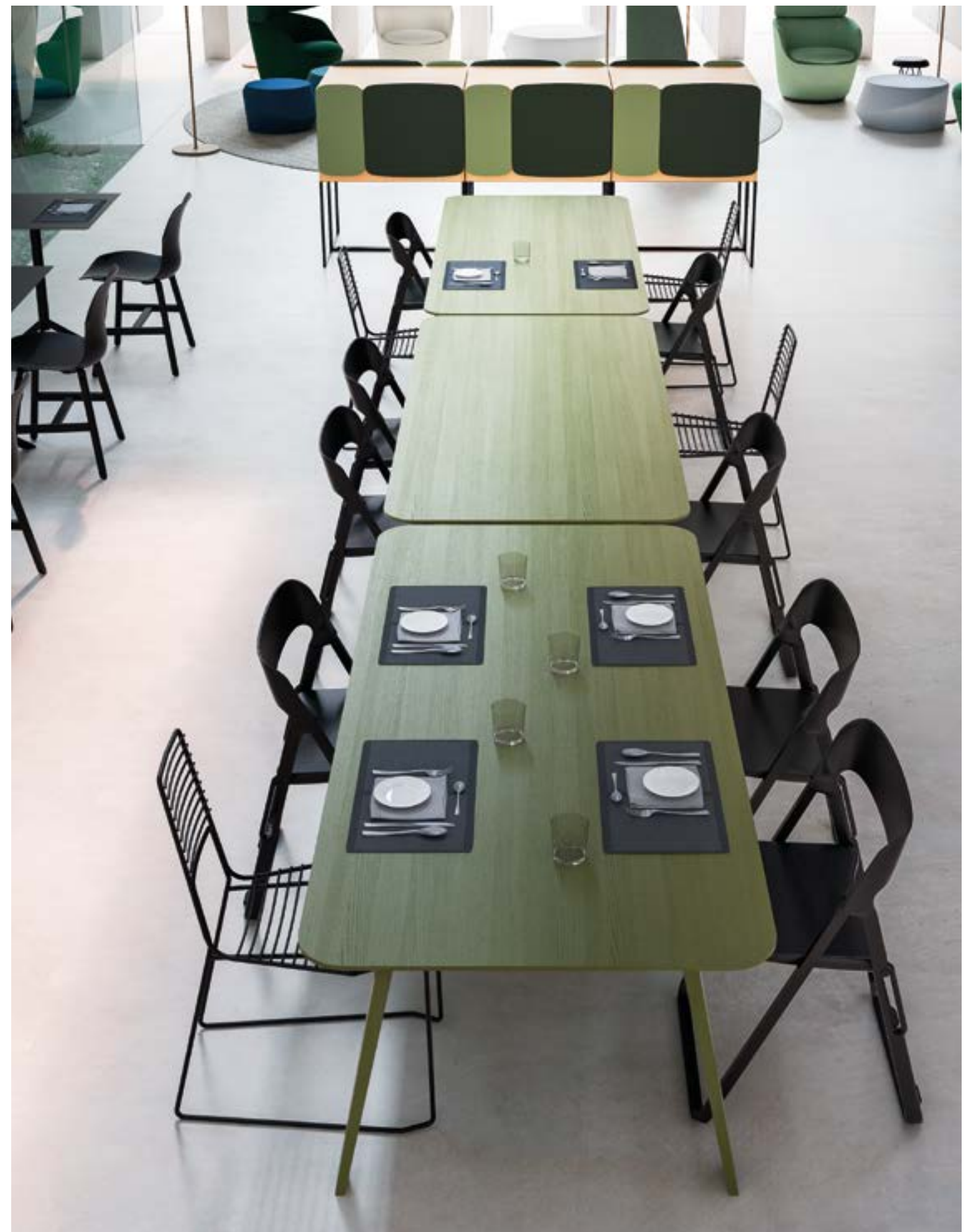



# REMEMBERME collection

design Tobias Juretzek  
2011

The race towards the future and the desire to keep the past alive coexist in Rememberme. A table that embodies the current focus on sustainability and recycling. Rememberme gives new life to objects which are unconscious memory capsules. The beginning of a project with infinite space for development and customization. On the surface of the table a special glass can be placed. It allows an optimal use of the product preserving its unique aesthetics, as well.

Lo slancio verso il futuro e la volontà di mantenere vivo il passato convivono in Rememberme. Un tavolo che si fa portavoce degli attuali temi sulla sostenibilità e riciclo e mezzo per dare una nuova vita a oggetti che sono inconsapevolmente ma profondamente portatori di ricordi e memorie. Un progetto che comincia oggi ma che prospetta ampi margini di sviluppo e personalizzazione. Sulla superficie del tavolo è possibile posizionare un apposito piano in vetro che permette un ottimale utilizzo del prodotto senza rinunciare alla sua peculiare estetica.

## MATERIALS AND FINISHES

Jeans and cotton t-shirts.

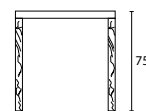
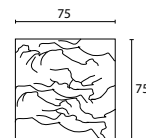

Glass top / Piano in vetro

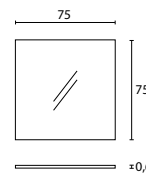

\* The café table can be customized with jeans and cotton t-shirts provided by the customer. To produce the café table only in jeans are necessary about 7kg of jeans. To produce the café table in jeans + cotton t-shirts are necessary 4kg of jeans and 3kg of cotton t-shirts. The colours of the t-shirts and of the pairs of jeans may vary from the original ones due to the treatment which they are subjected to.

Il tavolino può essere personalizzato con jeans e t-shirts in cotone forniti dal cliente. Per la versione solo jeans sono necessari 7 kg di jeans. Per la versione jeans + cotone sono necessari 4 kg di jeans + 3kg di magliette in cotone. I colori delle magliette e dei jeans potrebbero variare da quelli originali a causa dei trattamenti ai quali vengono esposti.

## MATERIALI E FINITURE

Jeans e magliette in cotone.



**1** Jeans + t-shirt are treated with the resin. Jeans + t-shirt vengono trattati con la resina.

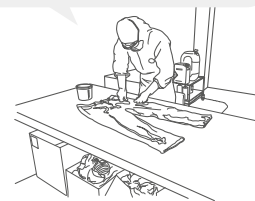

**2** They are inserted into the mould. Vengono inseriti nell'apposito stampo.



**3** Jeans + t-shirt and resin are allowed to dry. Jeans + t-shirt e resina vengono lasciati asciugare.

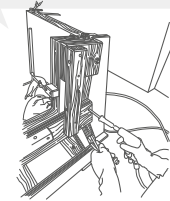

**4** Your table is ready. Il tuo tavolo è pronto.





# T1, T2 & T4

design C.S.C.  
2010/2015

Collection of coffee tables suitable for contract use.

## MATERIALS AND FINISHES

**T1**  
Top: white melamine, HPL or Werzalit.  
Structure: White painted metal or stainless steel (304, 306)  
for outdoor use.

**T2**  
Top: white melamine, HPL or Werzalit.  
Structure: chromed metal.

**T4**  
Top: white or black HPL.  
Structure: white or black painted metal for outdoor use.

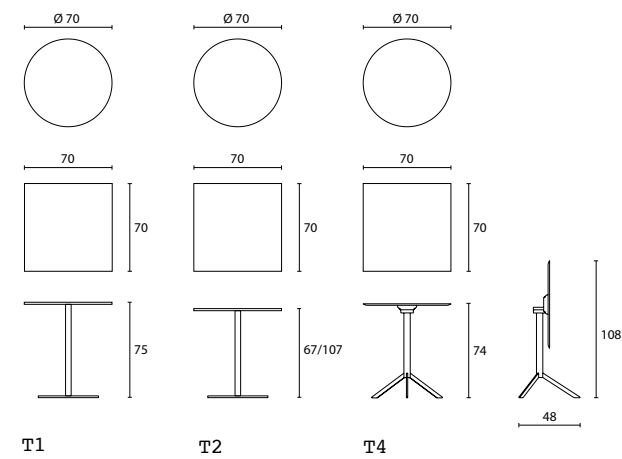

**T1 fixed / fisso**



Only with top in HPL or Werzalit and structure in steel.  
Solo con piani in HPL o Werzalit e struttura in acciaio.

**T2 gas lift / alzata a gas**



**T4 folding and stackable / pieghevole e impilabile**



Collezione di tavoli da bar o da caffè adatti al mondo del contract.

## MATERIALI E FINITURE

**T1**  
Piani: melaminico, HPL o Werzalit bianco.  
Strutture: Metallo verniciato bianco o acciaio inox (304, 306)  
per uso esterno.

**T2**  
Piani: melaminico, HPL o Werzalit bianco.  
Struttura: metallo cromato.

**T4**  
Piani: HPL bianco o nero.  
Struttura: metallo verniciato bianco o nero per uso all'esterno.

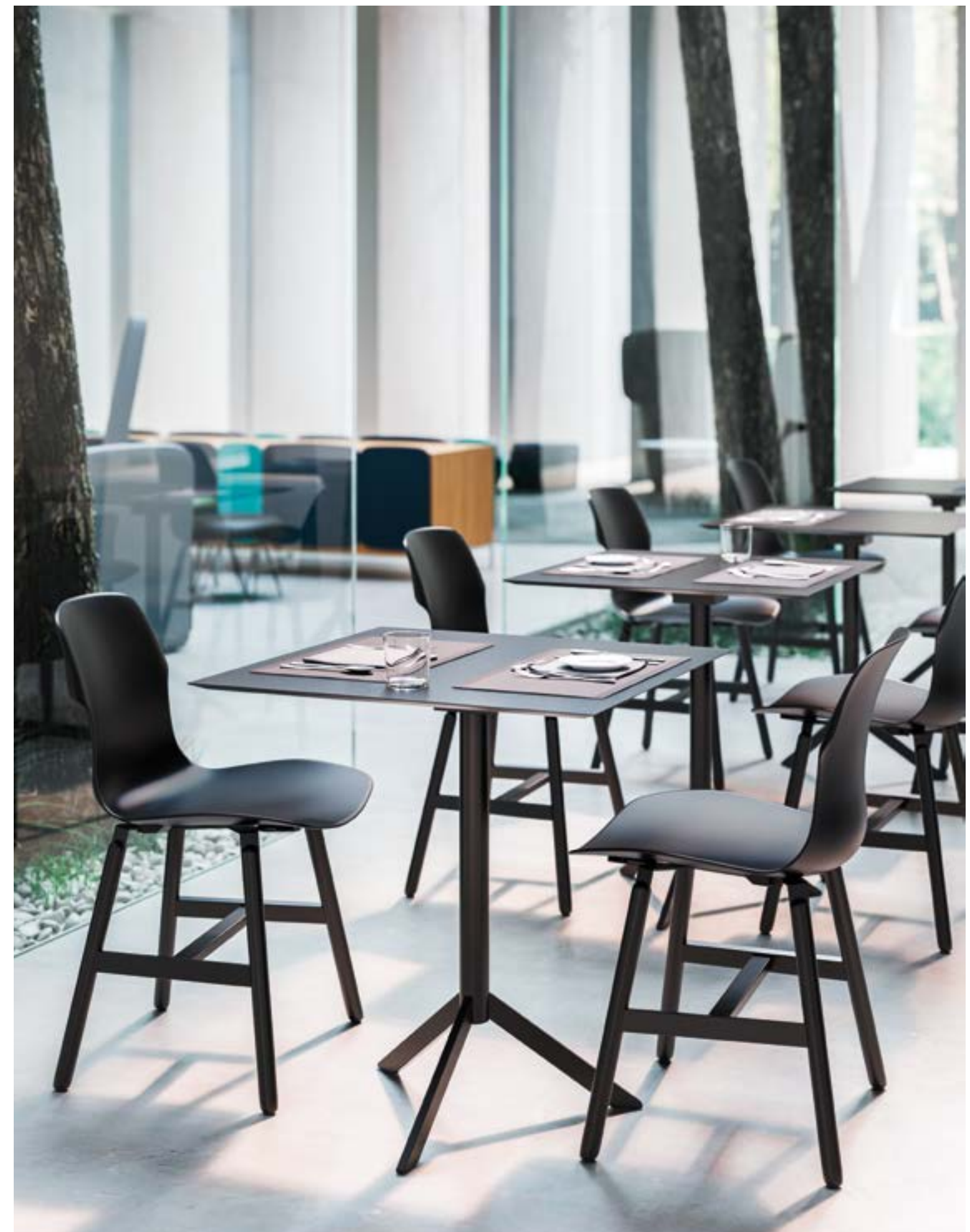



# ELLE METAL

design **Luca Nichetto**  
2015

Multi-function table, ideal for a tray or for use as a support for a notebook or tablet near a sofa, an armchair or a chaise-lounge.  
Elle Metal available in a high or low version with a metal base, 8 mm thick, tubular metal support column with optional 180°rotation of the top around the base. Structure available with a black or white epoxy lacquer finish.

## MATERIALS AND FINISHES

Top: white or black painted metal.  
Structure: white or black painted metal.

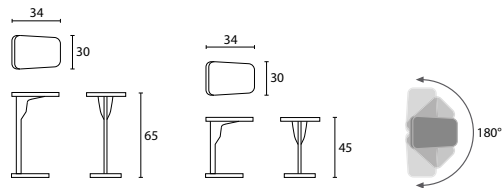

Tavolino multiuso, ideale per appoggiare un vassoio o per un utilizzo operativo come supporto per un notebook o un tablet vicino ad un divano, una poltrona o una chaiselounge.  
Elle Metal è disponibile nella versione alta o bassa con base in metallo spessore 8 mm, colonna di sostegno in metallo con possibilità di rotazione del piano di 180° rispetto alla base. Struttura verniciata con polveri epossidiche disponibile nelle finiture nero o bianco.

## MATERIALI E FINITURE

Piano: metallo verniciato bianco o nero.  
Struttura: metallo verniciato bianco o nero.





# LILY

design Marc Thorpe  
2015

Lily is inspired by the architecture of the flowering plant nymphaeaceae. Lily is a system of low lying pads and surfaces which operate at various heights to accommodate functions. High pads offers display and utility, while lower pads accommodate table in wood version and pouf (in fabric version). When Lily is combined with members of its family the spatial effect can produce unique hybrid interaction through the layering of the pads and surface.

## MATERIALS AND FINISHES

Top in fabric version: polyurethane foam with removable fabric cover or solid oak; natural solid oak or walnut painted oak.

Top in wood version: solid oak.

Structure: black painted metal (RAL 9005).

Tray: Solid natural oak or walnut painted solid oak.

Lily si ispira all'architettura della pianta della ninfea. È un sistema di piani e superfici che operano a varie altezze per offrire diverse funzioni. Il piano/vassoio più alto funge da porta oggetti, mentre il piano più basso funge da tavolo (nella versione in legno) o da pouf (nella versione in tessuto). Quando Lily è mescolato con altri membri della sua famiglia l'effetto spaziale può produrre un'unica interazione ibrida attraverso la stratificazione di piani e superfici.

## MATERIALI E FINITURE

Piano per la versione in tessuto: poliuretano espanso con rivestimento sfoderabile in tessuto in rovere naturale o tinto noce.

Piano per la versione in legno: rovere massello.

Struttura: metallo verniciato nero (RAL 9005)

Vassoio: legno massello rovere naturale o tinto noce.

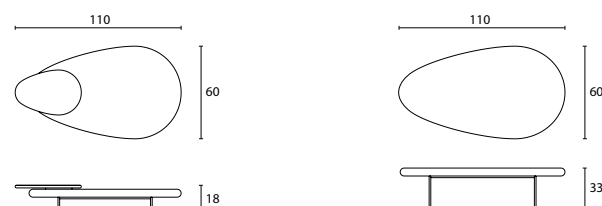

Fabric version (with tray)

Versione in tessuto (con vassoio)

Febrik Uniform Melange p.151

Wood version (without tray)

Versione in legno (senza vassoio)

Fabric version / Versione in tessuto



Wood version / versione in legno





# MEDUSE

design GamFratesi  
2009

A series of coffee tables inspired by the iconic shape of the jellyfish. The typical soft and smooth body encloses its internal structure, from which the tentacles are suspended. The coffee tables are constructed with a metal steel structure with a pressed sheet-metal top.

## MATERIALS AND FINISHES

Embossed painted metal also for outdoor use.

Tavolini da salotto ispirati ad un'iconica forma di medusa. Il caratteristico corpo rotondo, in metallo verniciato, racchiude una struttura interna dalla quale scendono sospesi i tentacoli in metallo verniciato in tinta con il piano.

## MATERIALI E FINITURE

Metallo verniciato gofrato anche per esterno.

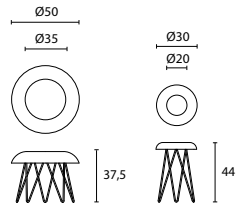

Small



RAL9016 RAL9005 RAL3004 RAL1019 Corten colour Hunter green

Large



RAL9016 RAL9005 RAL3004 RAL1019 Corten colour Hunter green





# TWINE TABLE

design Wis Design  
2008

Twine Table is a series of tables inspired by one of mankind's most simple inventions: the button. The table top is an over-size button, whilst the metal wire pierces and twists around the surface to create an elegant base. A playful and nostalgic addition to any interior. Available in a range of colours.

"The idea of the tables arose when the designers, Lisa and Anna, were looking into the world of construction. They had recently been working with some embroidery for an exhibition, and they asked themselves – is it possible to stitch a table together? Inspired by the idea of needlework, they passed a metal wire through a table top. The wire then became the legs as well as the structure. The playful Twine Tables, in the shape of a button, are completely at ease by a sofa, an easy chair or just by itself".

Linea di tavolini ispirata a una delle più semplici invenzioni dell'uomo: il bottone. Il piano del tavolino è infatti un enorme bottone, mentre la struttura è determinata da un filo di metallo che attraversa i 2 fori al centro del piano. Un tocco ludico e nostalgico. "L'idea è nata quando le designer Lisa ed Anna stavano facendo una ricerca sui vari metodi di costruzione. Avevano appena finito di preparare degli arazzi per una mostra e si chiesero 'sarebbe possibile cucire un tavolo?' Con l'idea del taglio e del cucito hanno passato un filo di metallo attraverso il piano del tavolo, trasformando così il filo nelle gambe e struttura portante stessa del tavolo. I Twine Tables, con la forma di un bottone, possono essere collocati in vari contesti dal soggiorno di casa, un'elegante sala d'attesa o una boutique di moda."

## MATERIALS AND FINISHES

Top: White lacquered MDF or solid oak natural or walnut painted oak.  
Structure: black, white or bronze painted metal.

## MATERIALI E FINITURE

piano: MDF laccato bianco o rovere massello naturale o tinto noce.  
Struttura: metallo verniciato nero, bianco o bronzo.

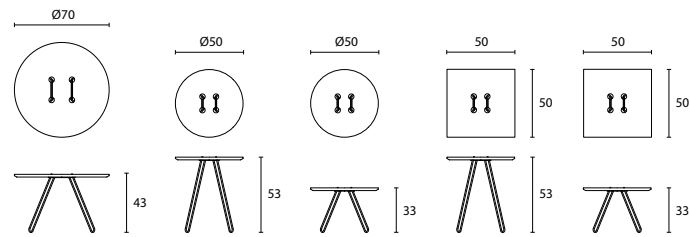

Some examples / Alcuni esempi

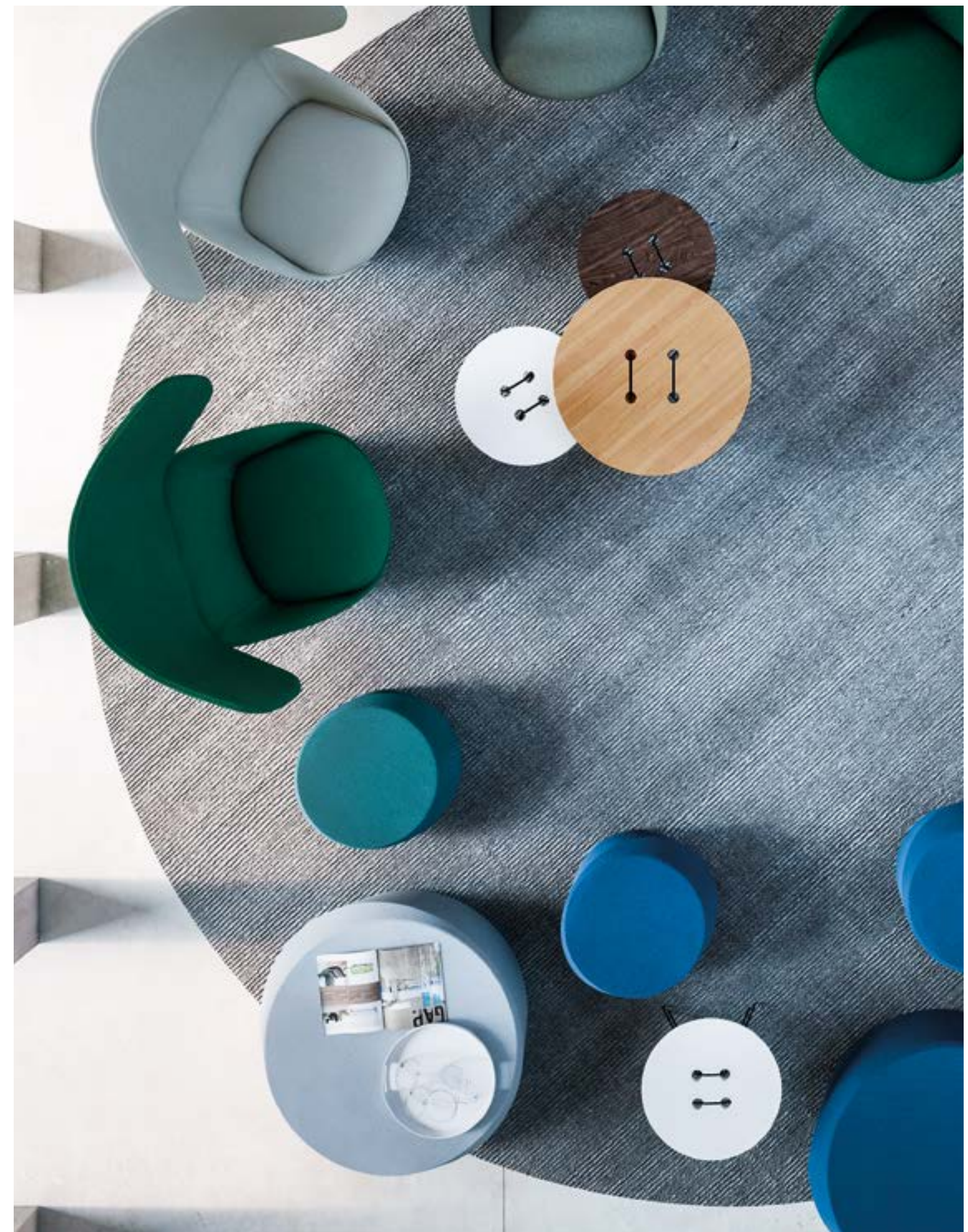



# KORZINA & ZONTIK

design **Karim Rashid**  
2006

It takes its name from the Russian language, translating simply as 'can', but Korzina is much more: it satisfies our needs to dispense unwanted objects and materials. The Zontik umbrella stand keeps things well organized and shows them, as well. Zontik diligently collects and contains any water that may drip from wet umbrellas. Korzina and Zontik are produced in polyethylene and solution-dried by means of rotational moulding.

## MATERIALS AND FINISHES

Matt polyethylene or painted polyethylene.

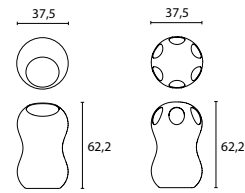

**KORZINA** in matt polyethylene / polietilene opaco



**KORZINA** in painted polyethylene / polietilene verniciato



**ZONTIK** in matt polyethylene / polietilene opaco



**ZONTIK** in painted polyethylene / polietilene verniciato



Il suo nome significa 'cestino', ma Korzina è utilissimo per nascondere tutti quegli oggetti inutili e invadenti che occupano il nostro spazio.

Il portaombrelli Zontik mantiene l'ordine razionalizzando i contenuti. Dotato di sei appositi fori, raccoglie e trattiene l'acqua che gocciola dagli ombrelli mantenendo asciutto il pavimento.

Korzina e Zontik sono realizzati in polietilene tinto in massa e ottenuti mediante stampaggio rotazionale.

## MATERIALI E FINITURE

Polietilene opaco o polietilene verniciato.





# ALBERTO

design Fabrica  
2005

Ironico clothes horse produced in polyethylene by means of rotational moulding, the garden-friendly Alberto is both sunlight and water resistant. Alberto is designed to be fixed directly to the floor. By adding the specially designed square metal base, Alberto can also be used individually, as a decorative object or coat hook.

## MATERIALS AND FINISHES

Polyethylene.

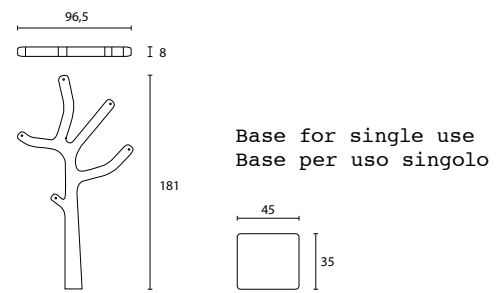

\* Carrying capacity with strings 45 kg.  
String not included.  
Portata massima con fili 45 kg.  
Il filo non è incluso.



Ironico stendino per biancheria in polietilene tinto in massa mediante stampaggio rotazionale, ideale per il giardino o il terrazzo poiché resistente alla luce ed all'acqua. Il fissaggio è previsto direttamente a terra. Alberto può essere utilizzato anche singolarmente, come oggetto di decoro o appendiabiti, mediante una base quadrata in metallo.

## MATERIALI E FINITURE

Polietilene.

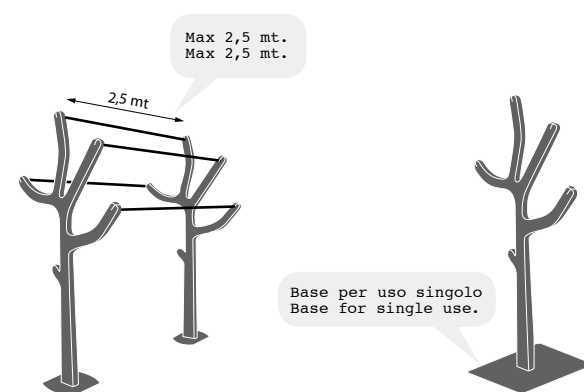



# HOO

design **Pastorino & Suarez**  
2005

A floor standing coat rack available with optional umbrella stand. Characterised by a minimal design and refined lines HOO is perfect for any interior. Perfect for the home, where its simplicity allows it to fit in with different furniture styles. Perfect also for the office, public spaces and contract use.

## MATERIALS AND FINISHES

Structure: chromed steel.  
Hooks: polyamide.

Carrying capacity: 10 Kg per coat-hook.

Appendiabiti a stelo con o senza portaombrelli dal design minimalista. La linea sobria ne fa un oggetto d'arredamento adatto a qualsiasi ambiente. Perfetto per la casa dove grazie alla sua versatilità può facilmente adattarsi al confronto con altri stili d'arredamento, ideale per l'ufficio, i luoghi pubblici o lo spazio collettivo.

## MATERIALI E FINITURE

Stelo: acciaio cromato.  
Appendini: poliammide.

Portata: 10 kg per appendino.

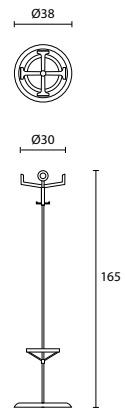



**XX**

design Josh Owen  
2006

The XX coatrack takes its name from the simplicity of its form and has been conceived as a very practical piece of design. Elaborated "X"s are formed by two intersecting pieces of solid oak to achieve the goal of stability and usability. XX can be installed quickly and it is easy to carry.

**MATERIALS AND FINISHES**

Solid natural oak, white or walnut painted solid oak.

Carrying capacity: 10 Kg per coat-hook

L'appendiabiti XX trae il nome dalla sua semplice forma ed è pensato come un elemento d'arredo estremamente pratico. Per conferire stabilità e funzionalità all'oggetto vengono utilizzati due pezzi intersecati di rovere massello dalla forma di grandi "X". Facile da trasportare, montare e subito pronto all'uso.

**MATERIALI E FINITURE**

Legno rovere massello naturale, tinto bianco o noce.

Portata: 10 kg per appendino.

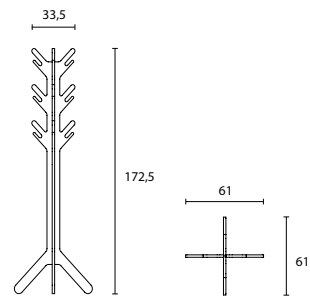



# COMPASS

design GamFratesi  
2013

Compass is a clothes valet made of solid wood, created thanks to the transformation of technical-functional design details into graphic elements.

In this piece, an extraordinarily iconic aesthetic is fashioned: the striking elements of the of the object – the compass in this particular case – lend the product a simple and essential form. Compass is available in three different finishes: natural oak, white and black, with metallic circular features and a leather strap.

## MATERIALS AND FINISHES

Natural oak, with black leather strap and circular feature in black metal.

White stained natural oak, with black leather strap and circular feature in black metal.

Black stained natural oak, with black leather strap and circular feature in gold metal.

Compass è un servomuto in rovere legno massello, il cui progetto si basa sulla trasformazione del disegno del dettaglio tecnico-funzionale in elemento grafico.

Si crea così un'estetica fortemente iconica: gli elementi dell'oggetto di richiamo il compasso, per l'appunto, conferiscono al prodotto una forma semplice ed essenziale. Compass è proposto in tre finiture, rovere naturale, bianca e nera, con dettaglio circolare in metallo e fascia in cuoio.

## MATERIALI E FINITURE

Rovere naturale con cinghia in cuoio nero e dettaglio circolare in metallo nero RAL 9005.

Rovere naturale tinto bianco RAL 9010 con cinghia in cuoio nero e dettaglio circolare in metallo nero RAL 9005.

Rovere naturale tinto nero RAL 9005 con cinghia in cuoio nero e dettaglio circolare in metallo color oro.

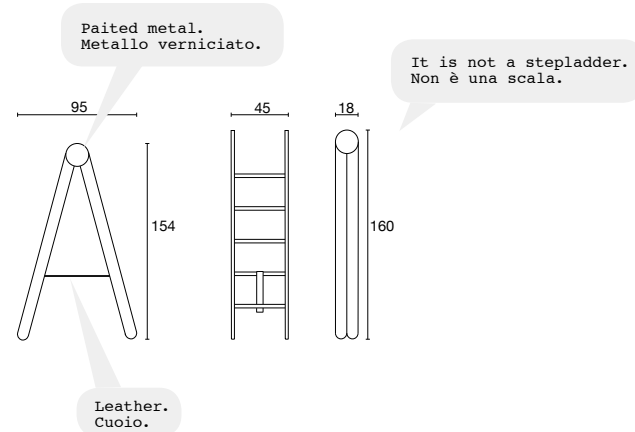



# TWEE T.

design Jake Phipps  
2014

Twee T. is a system of lamps projected by Jake Phipps for Casamania. The idea of cage, retrace the past tradition of canary in homes: from the Egyptian civilizations and Roman times, we can see the canary presence in the houses; in the Middle Age and in the English courts was a good upbringing sign to have them in lounges. In this way, an icon of british high-ranking status became a lamp-object. A figure symbol, enhanced by gold plating and yield useful by its illuminating function. The little birds are made of BOSA hand decorated ceramics, black painted or plated in 24 carat gold; the structure of metal rod black painted or gold plated in the total gold version. The LED lighting fixture is on the base of the cage, covered by a double polycarbonate shielding, that on the one hand illuminates the room and on the other hand illuminates the inside of the cage.

## MATERIALS AND FINISHES

Cage: metal rod black painted or 24 carat gold plated.  
Birds: hand decorated ceramics (Bosa), black painted or 24 carat gold plated.  
The led lighting fixtures on the base of the cage, covered by a double polycarbonate shielding, that on the one hand illuminates the room and on the other hand illuminates the inside of the cage.

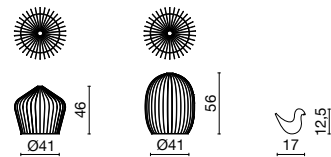

CE 1° IP20 19W 250V 48 micro led  
Electrical cable lenght 2m.  
Lunghezza cavo elettrico 2m.



Some example / Alcuni esempi



Twee T. è un sistema di lampade progettato da Jake Phipps per Casamania. L'idea della gabbia ripercorre la tradizione del passato del canarino nelle case: già dalle civiltà egizie e ai tempi dei romani, si rileva nelle abitazioni la sua presenza; nel Medioevo e nelle corti inglesi è un segno di buona educazione averli nei salotti. Così, un'icona dello status altolocato britannico si trasforma in una lampada-oggetto. Una figura simbolo, impreziosita dalla placcatura in oro e resa utile per la sua funzione illuminante. Gli uccellini sono realizzati in ceramica BOSA, decorata a mano, verniciata nera o placcata in oro 24 carati; la struttura in tondino di metallo verniciato nero o placcato oro, nella versione total gold. Il corpo illuminante a led è nella base della gabbia, coperto da una doppia schermatura in polycarbonato, che da un lato illumina l'ambiente, dall'altro l'interno della gabbia.

## MATERIALI E FINITURE

Gabbia: tondino di metallo verniciato nero o placcato oro 24 carati.  
Uccellino: ceramica (Bosa) decorata a mano verniciata nera o placcata oro 24 carati.  
Il corpo illuminante a led è nella base della gabbia, coperto da una doppia schermatura in polycarbonato, che da un lato illumina l'ambiente, dall'altro l'interno della gabbia.







# GRANNY

design Pudelskern  
2010 / 2012

Granny is a reminiscence of childhood. Pure natural wool from sheep bred on green alpine pastures in the remote valleys of the Tyrol the harsh climate and the rough terrain is home to high quality handcrafted production rather than the industrial. Each lamp can be tracked back to the flock where the wool came from. Intervention at different stages of the cycle has refined the existing products and new products were developed from half-finished materials. For "Granny" thick woollen threads are used to produce a raw yet cosy surface. The threads are produced by a family business in the Tyrol, with each lamp hand-knitted by a collective of home-based workers in the Netherlands. A natural treatment is applied, making the wool flame resistant and resistant to moth and mite infestation.

## MATERIALS AND FINISHES

The wool is resistant to fire, attack from moths and the effects of humidity.  
White lamp shade red wire.  
Red lamp shade black wire.  
Grey lamp shade grey wire.  
The switch is in the same colour as the electrical cable.

CE  1° IP20 

The lamp is supplied with light bulb.  
Max 100W 250V E27  
La lampada viene fornita con la lampadina.  
Max 100W 250V E27

Floor lamp / Lampada da terra



Table lamp  
Lampada da tavolo

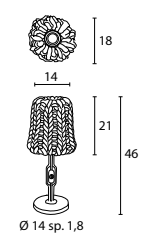

Granny è un ricordo d'infanzia. Lana pura e naturale proveniente da allevamenti in verdi pascoli alpini delle remote valli del Tirolo dove il rigido clima e il duro terreno rappresentano la cornice della tradizionale produzione manifatturiera piuttosto che di quella industriale. Ogni lampada può essere, infatti, ricondotta al gregge da cui proviene la lana. Interventi a differenti stadi del ciclo produttivo hanno raffinato i prodotti della tradizione creandone di nuovi, sviluppati da materiali semilavorati. Per produrre la ruvida ed accogliente superficie della "Granny" vengono impiegati grossi fili di lana intrecciati, prodotti da una piccola impresa familiare tirolese. I fili sono poi intrecciati a mano da una collettività di lavoratori olandesi. Viene inoltre applicato un trattamento naturale anti tarne ed anti acari.

## MATERIALI E FINITURE

Lana ignifuga, antitarma, antiacaro e non attaccabile dall'umidità.  
Paralume bianco filo rosso.  
Paralume rosso filo nero.  
Paralume grigio filo grigio.  
Interruttore in tinta con filo elettrico.

Large and small ceiling lamp / Lampada sospesa grande e piccola  
Electrical cable length 1,9 m / Lunghezza cavo elettrico 1,9 m



Wall lamp  
Lampada da parete

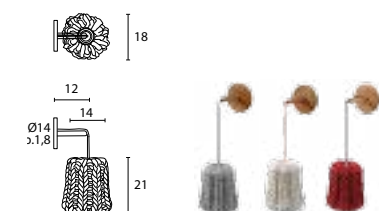



# BLOOM

design **Giulio Iacchetti**  
2010

Bloom, selfstanding and double face bookshelf, Brings together the most difficult challenges and resolves the problem of formal distortion by simply rotating the weight bearing structural elements by 45°. This guarantees stability and visually simplifies the entire bookshelf. The vertical elements are crafted from aluminium tubing with special runners which allow the 'buds' to be attached. These are crafted in dye-cast aluminium and hold up the shelves. Bloom allows to create elegant lounge compositions, archives, library...

## MATERIALS AND FINISHES

Uprights: aluminium.  
Shelves: oak or walnut melamine.

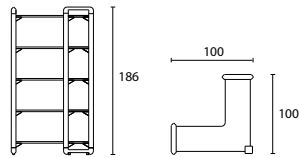

1 modulo H 69 con 2 ripiani / 1 module H 69 with 2 shelves

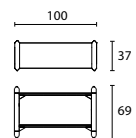

1 modulo H 108 con 3 ripiani / 1 module H 108 with 3 shelves

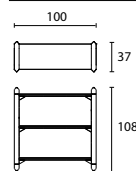

1 modulo H 186 con 5 ripiani / 1 module H 186 with 5 shelves

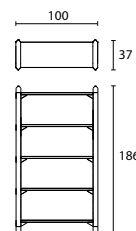

Bloom, libreria autoportante e bifacciale, raccoglie le sfide più ardue e risolve il problema della controventatura tramite la semplice rotazione di 45° delle strutture portanti, assicurando stabilità e alleggerendo visivamente la forma della libreria. I ritzi verticali in profilato di alluminio tubolare a sezione quadrata sono dotati di guide che permettono l'innesto dei germogli, in pressofusione di alluminio, sui quali si appoggiano i piani. Il sistema Bloom permettedi realizzare eleganti composizioni da salotto, archivi, librerie...

## MATERIALI E FINITURE

Steli: alluminio verniciato champagne.  
Piani: melaminico rovere o noce.





# WEB STOPPER

design Menguzzato & Nascimben  
2006

Aluminium wall mounted shelf with essential lines which fit in every work space both for dimension and colour.

Sistema e mensola in alluminio dalle linee essenziali che si adattano per dimensione e colore ad ogni ambiente di lavoro.

## MATERIALS AND FINISHES

Embossed painted aluminium.  
Supports and lateral shelf caps in plastic.

## MATERIALI E FINITURE

Alluminio verniciato goffrato.  
Supporti e tappi laterali di chiusura in plastica.

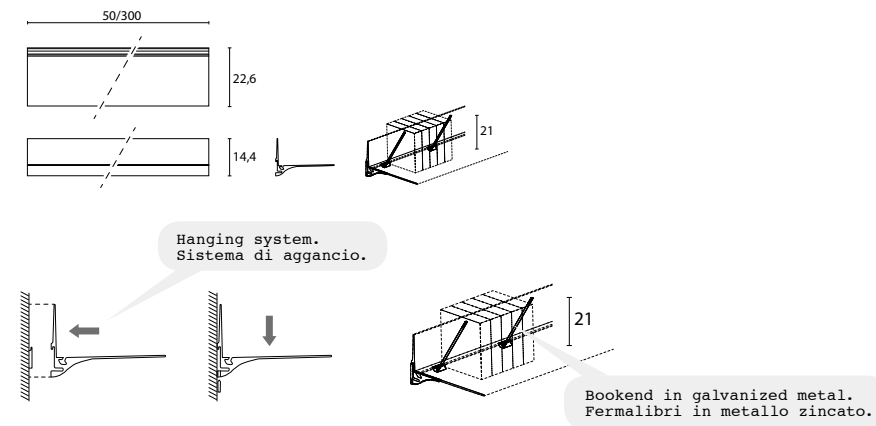

\* Customized cuts on request (with a surcharge)  
Carrying capacity: 100kg per meter.

Taglio a misura su richiesta (con sovrapprezzo)  
Portata 100kg al metro.









# ALMA

design Studio 63  
2011 / 2012

Leggerezza e forza, linearità della percezione e sregolatezza del dettaglio, Alma soddisfa queste contraddizioni grazie alle differenti altezze, profondità e misure dei moduli. Tre moduli piccolo, medio e grande che si possono appendere e comporre a proprio gusto. Inoltre, grazie all'inserimento di pannelli in tessuto, si potrà personalizzare ogni modulo, rendendo la libreria unica e colorata.

## MATERIALS AND FINISHES

Structure: embossed painted metal.  
Panels: fabric.



### Small module / Modulo piccolo

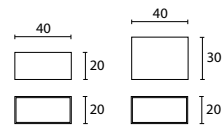

### Medium module / Modulo medio

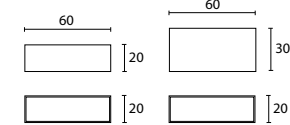

### Large module / Modulo grande

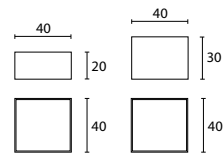

### Fabric panels for / Pannello tessuto per

#### Small module / Modulo piccolo



#### Medium module / Modulo medio



#### Large module / Modulo grande



Lightness and strength – upon first glance Alma is linear, but closer inspection reveals a random side. Three modules derive from the basic element – small, medium and large – which can be hanged and arranged to one's own taste. Furthermore, thanks to the fabric panels, it is possible to customize each module, making the bookcase unique and colorful.

## MATERIALI E FINITURE

Struttura: metallo verniciato gofrato.  
Pannelli: tessuto.





# NETWORK

design Neuland, Paster & Geldmacher  
2014

Bookcase Network, designed by Neuland Paster & Geldmacher for Casamania, is part of a project aimed at creating a new and multi-functional bookcase.

A light bookcase – of a slender and modular structure – with floating panels, made of form leatherette which can change configuration in line with the metallic structure of the bookcase, allowing a total customizing of the composition at the tip of ones hands. In this way it creates a game of spaces between shelves, which invite one to combine and to change the design and function at any given time.

## MATERIALS AND FINISHES

Structure: bronze or anthracite painted metal.  
Shelves: floating panels, thermoformed Leatherette which can change use configuration in line with the metallic structure of the bookcase, allowing a total customizing of the composition. In this way it creates a game of spaces between shelves, which invites us to combine and to change the rhythm anytime.

Each bookshelf can hold max 15 shelves.

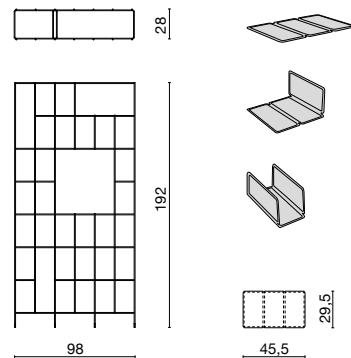

\* Kit 5 shelves per colours.  
Double face and selfstanding.  
Shelves carrying capacity 5 Kg  
Fittings for structure are included.

- Kit 5 ripiani per colore.  
Bifacciale autoportante.  
Portata ripiani 5 Kg  
Sono previsti agganci di fissaggi per più librerie.



La libreria Network, progettata da Neuland Paster&Geldmacher per Casamania, fa parte di un progetto volto alla creazione di una nuova tipologia di librerie.

Una libreria leggera - dalla struttura esile e modulare - dotata di pannelli mobili termoformati in similpelle che possono cambiare configurazione di utilizzo in linea con la struttura metallica della libreria, consentendo così una totale personalizzazione della composizione. In questo modo si crea un gioco di spazi tra i ripiani, che invita a combinare e a cambiare il ritmo in qualsiasi momento.

## MATERIALI E FINITURE

Struttura: metallo verniciato bronzo o antracite.  
Ripiani: termoformati in similpelle che cambiano configurazione di utilizzo in linea con la struttura, grazie alle calamite riposte all'interno.

Ogni libreria può contenere max 15 ripiani.

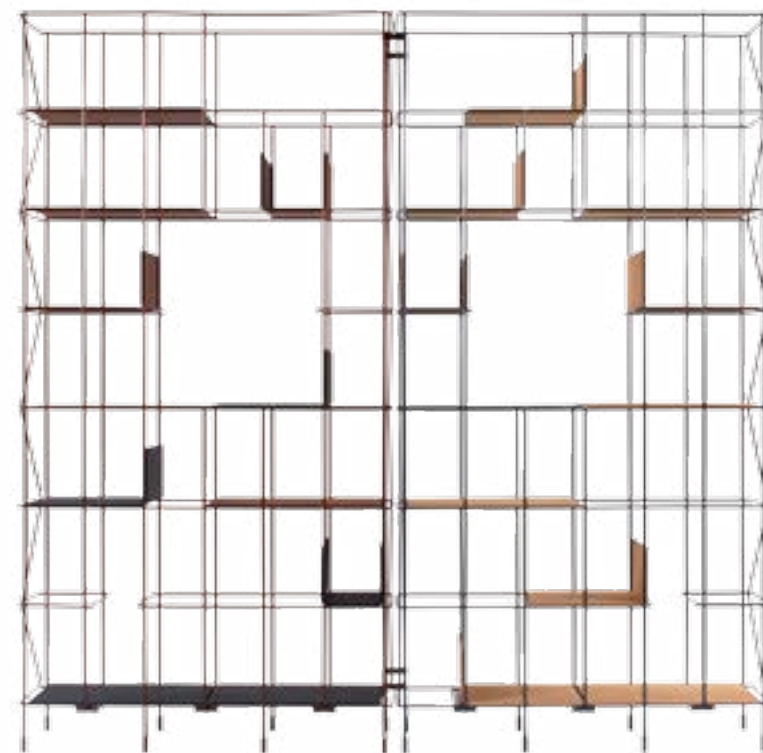



# ROBOX

design Fabio Novembre  
2011

A bookshelf, a man-sized robot, a beautiful and distant childhood memory made real, a "new household hero", created by Fabio Novembre. Robox embraces all these definitions and lends itself easily to satisfy a variety of uses. This new design by Fabio Novembre is open to multiple interpretations adding to and personalizing its meaning and value. This anthropomorphic bookshelf animates the space it occupies, with its bright red heart, Robox is exactly the same height as the designer who created it.

## MATERIALS AND FINISHES

Embossed painted metal.

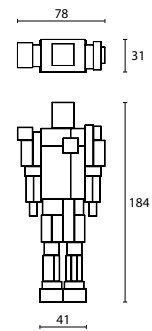

RAL 9010

Limited Edition

Una libreria, un robot di dimensioni umane, la concretizzazione di un suggestivo e lontano ricordo infantile, un "nuovo eroe domestico", come l'ha definito Fabio Novembre, Robox abbraccia tutte queste definizioni e si presta facilmente a soddisfarne altre. Il nuovo progetto di Fabio Novembre si rende disponibile a molteplici interpretazioni che ne aumentano e ne personalizzano il significato e il valore. E' una libreria antropomorfa, dotata di un cuore rosso e di un'altezza assolutamente umana che condivide con il suo designer, che veste di inaspettato lo spazio che la ospita.

## MATERIALI E FINITURE

Metallo verniciato goffrato.





# OPUS INCERTUM

design Sean Yoo  
2005

Flexible and light bookshelf or display cabinet in recyclable expanded polypropylene, Opus Incertum can be a multi-functional dividing wall if put one close or upon the other. 100% recyclable materials.

## MATERIALS AND FINISHES

Expanded polypropylene.  
Carrying capacity: 50 Kg (1 Opus);  
25 Kg (2 Opus stacked)

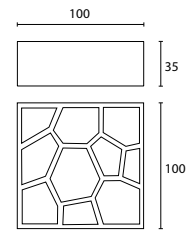

\* 100% recyclable expanded polypropylene, without metal inserts. (ATTENTION - the product is NOT polystyrene). Structure composed of irregularly shaped closed 'cells', combining quality surface finishing with optimal mechanical structure and characteristics (resistance to pressure, surface resistance, impermeable). The light weight nature of the product makes it easily transportable. The finished material has no emissions whatsoever, and it suitable for direct contact with foodstuffs.

Polipropilene espanso 100% riciclabile, monomaterico senza inserti metallici. (ATTENZIONE: non è polistirolo) Struttura alveolare a cellule chiuse, che unisce buona finitura superficiale e ottima struttura meccanica. Buone caratteristiche meccaniche (resistenza a compressione, resistenza superficiale, impermeabilità) La leggerezza del prodotto finito lo rende facilmente trasportabile. Il materiale finito non ha emissioni di nessuna natura ed è idoneo anche al contatto diretto con alimenti.

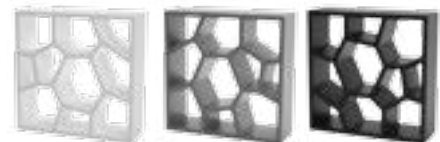

Design  
Distinction-  
Furniture  
2006

Versatile e leggera libreria o espositore in polipropilene espanso, può assolvere la funzione di comune libreria, come parete divisoria componibile in altezza e lunghezza accostabile nei colori e nell'orientamento delle partizioni interne, oppure tramutarsi in espositore per oggettistica. Materiale 100% riciclabile.

## MATERIALI E FINITURE

Polipropilene espanso.  
Portata: 50 Kg (1 Opus);  
25 Kg (2 Opus sormontati)









# URBAN

design **Claudio Bellini**  
2009

The 'L' shaped module measuring 140x 35cm can be used in any position. A system without hooks or joints which allows the user to create walls, screens, horizontal and vertical elements; angles, benches, entertainment systems – everything that comes to mind. The niches carved out of the piece underline the monolithic and solid nature of the Urban shelving unit. A modern piece which stands above the whims of fashion. The infinite possibilities of composition and the a vast choice of colours allow the user to create surprising landscapes and furnish her spaces in a dynamic and bright way. The apparent simplicity of the Urban shelving unit contrasts with the technical difficulties encountered in the rotational moulding of a plastic object with large flat surfaces.

## MATERIALS AND FINISHES

Polyethylene.

Carrying capacity: 200 Kg.

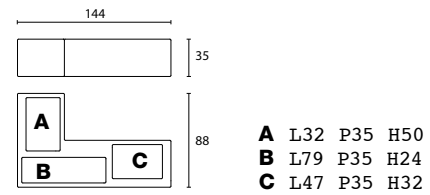

White / Black  
bianco / nero



Grey / grigio



Corten colour



Hunter green



Un modulo ad elle di un metro e quaranta per trentacinque centimetri di profondità, utilizzabile in qualunque verso, privo di vincoli ed agganci, che consente di realizzare pareti, divisori, elementi verticali, orizzontali, angoli, piccole panche, consolle porta tv, hi-fi...qualsiasi cosa. Le nicchie ricavate nel pezzo fanno risaltare la massa di questo oggetto solido, monolitico, sempre attuale ed indifferente alle mode. Le infinite aggregazioni ed un'ampia gamma di colori, consentono inoltre di dar vita a sorprendenti paesaggi che arredano lo spazio in modo solare e dinamico. L'apparente semplicità della libreria Urban in realtà nasconde una grande sfida tecnologica: realizzare un elemento in materiale plastico, polietilene, dalle grandi superfici planari in stampaggio.

## MATERIALI E FINITURE

Polietilene.

Portata 200 Kg.





# CHARIOT

design GamFratesi  
2012

Chariot is a mobile table consisting of three simple elements joined together: wheels, trays and structure. The wheels, which in common carts are usually small, are brought to the extreme size, becoming the iconic element of the project. The rubber profile is inserted into the wheels for easy movement; the two trays act as storage compartments, the metal structure is also a handle: slightly raising the cart, it can be moved.

## MATERIALS AND FINISHES

Structure: painted metal.  
Trays and wheels: Fluorescent red lacquered mdf or natural solid oak or white, black or sugar paper painted solid oak.

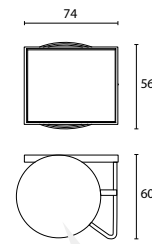

Ø60cm / sp.2,5cm



RAL 3026

 Packed in a wooden crate  
Imballato su cassa in legno



Chariot è un tavolino mobile composto da tre semplici elementi uniti tra loro: ruote, vassoi e struttura. Le ruote, che nei comuni carrellini sono solitamente piccole, vengono portate a estreme dimensioni, diventando l'elemento iconico del progetto. Il profilo in gomma inserito nelle ruote ne facilita il movimento; i due vassoi fungono da portaoggetti; la struttura metallica è anche una maniglia: sollevando leggermente il carrello verso l'alto sarà possibile spostarlo.

## MATERIALI E FINITURE

Struttura: metallo verniciato.  
Vassoi e ruote: mdf laccato rosso fluo o rovere massello naturale o tinto bianco, nero o carta da zucchero.



Easy to move.  
Facile da spostare.





# COLOR FALL

design Garth Roberts  
2014

Color Fall, designed by Garth Roberts for Casamania, is a shelf and bookcase wall (bracket and bookcase) which, in its essential form, packs the power of color. The series is composed of a framed wall and a unit to floor.

In all formats, the dynamic nature of the color and the balanced proportion of the shelves make the elements delicate decorative signs.

It is the set of endless colored lines, that in a cascade way, fill volumes and immediately convey the energy of the color.

## MATERIALS AND FINISHES

Structure: oak melamine.  
Digital print multicolor.  
Shelves in polished laquered MDF.

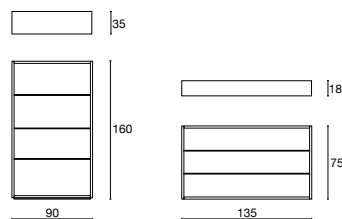

Color Fall, progettata da Garth Roberts per Casamania, è una mensola a parete e libreria che, nella sua forma essenziale, racchiude la forza del colore.

La serie è formata da una parete incorniciata e da una unità a pavimento.

In tutti i formati, la natura dinamica del colore e la proporzione equilibrata degli scaffali rendono gli elementi segni decorativi delicati.

È l'insieme di infinite linee colorate, che a cascata riempiono i volumi e trasmettono a colpo d'occhio l'energia del colore.

## MATERIALI E FINITURE

Struttura: melaminico rovere.  
Interno: stampa digitale multicolor.  
Piani in Mdf laccato opaco.

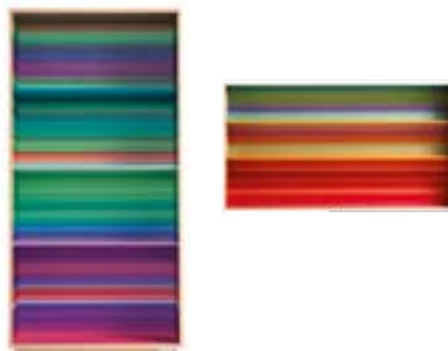



# INDUSTRY

design Benjamin Hubert  
2011

Industry is a double face and selfstanding library inspired by architecture and by the deconstruction of an expanding urban landscape. Contemporary buildings, industrial landscapes, construction sites and urban architecture are the inspiration behind this design by young British designer Benjamin Hubert. The bookshelf is a microcosmic reflection of the space which surrounds us as seen through the use of various natural materials. Materials typically found in our cities (concrete, metal, timber) remain separate but in the Industry Bookshelf are unified by a white painted metal frame that brings to mind scaffolding - the founding principle and the expressive power of Industry.

## MATERIALS AND FINISHES

Structure: white painted metal.  
Modules: natural fir, cement lacquered MDF, metal with corten finish and black painted fir.

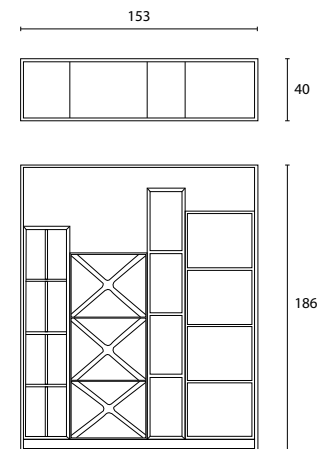

Industry è una libreria bifacciale e autoportante che si ispira all'architettura e al decostruttivismo di un paesaggio urbano in espansione. Le costruzioni contemporanee, i paesaggi industriali, i cantieri, le realtà e architetture cittadine hanno guidato questo progetto del giovane designer inglese Benjamin Hubert, che vuole riproporre nel microcosmo-libreria lo spazio presente che ci circonda grazie all'utilizzo e la lavorazione di materiali essenziali e naturali. La presenza, o quantomeno l'apparenza, di materiali centrali e tipici delle nostre città (cemento, metallo, legno) diversi tra loro ma riuniti in un frame di metallo verniciato bianco che ricorda un'impalcatura, costituisce il principio fondante e la forza espressiva di Industry.

## MATERIALI E FINITURE

Struttura: metallo verniciato bianco.  
Moduli: abete naturale, MDF laccato cemento, metallo finitura corten, e abete tinto nero.





# LEGATO

design **Claesson Koivisto Rune**  
2014

Legato is a wood cabinets system, inspired by artist Ellsworth Kelly's works, stands out due to its bold personality attributed by the particular form of the doors: neither square nor round, devoid of a precise geometry. If positioned next to each other in series, they create different combinations, colored and funny, ideal for an open and multifunctional space.

## MATERIALS AND FINISHES

Structure: melamine.  
Doors: lacquered MDF.  
Feet: painted metal.

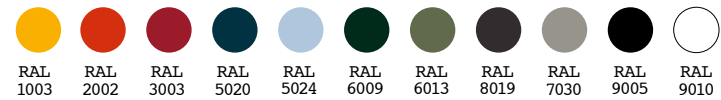
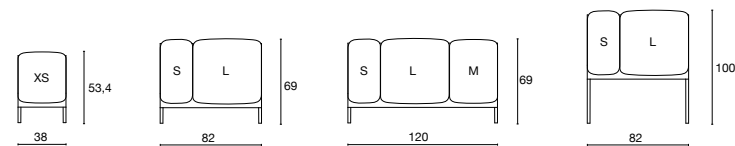

Some examples / Alcuni esempi

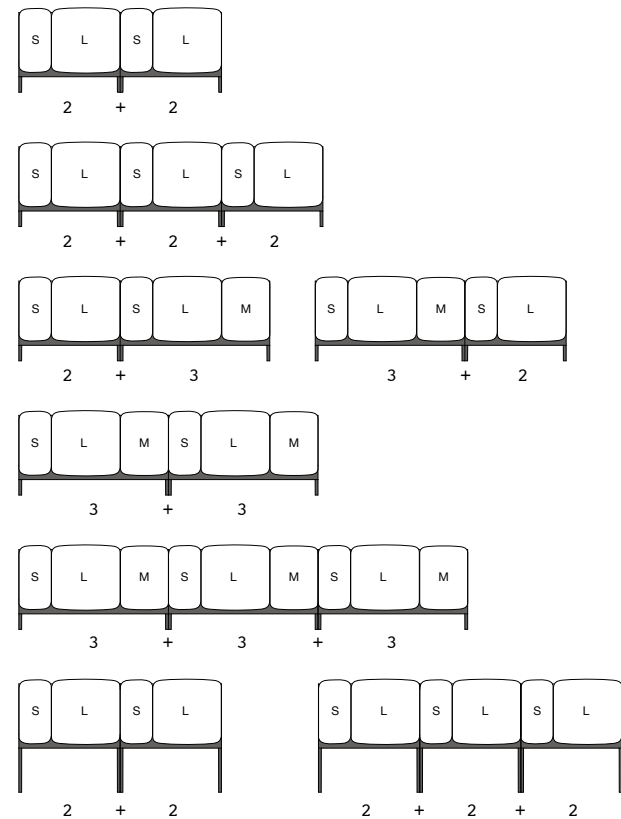

Legato è un sistema di mobili contenitori in legno, ispirata alle opere dell'artista Ellsworth Kelly, si contraddistingue per la personalità leggera, conferita dalla particolare forme delle ante: né quadrate, né rotonde, prive di una geometria precisa. Se posizionate l'una accanto all'altra in serie, creano diverse combinazioni, colorate e divertenti, ideali per uno spazio aperto e multifunzionale.

## MATERIALI E FINITURE

Struttura: melaminico  
Ante: Mdf laccato.  
Piedi: metallo verniciato.

doors / ante

**XS** L38 H37  
**S** L26 H53  
**M** L37 H53  
**L** L56 H53



One door cabinet  
Mobile contenitore  
con anta singola



Three doors  
cabinet  
Mobile  
contenitore  
con tre ante



Mobile contenitore  
con due ante  
Two doors cabinet









# TOSHI

design Luca Nichetto  
2013

Toshi, meaning city in Japanese, is a system of mobile containers which calls to mind the mosaic decorations to be found in certain buildings in Tokyo. The fresh and essential lines optimise and emphasise the geometric design engraved on the doors of the pieces. Each and every size of cupboard has its own distinct pattern, making the module unique. The reference to Japanese architecture is obvious: a micro city which develops its essentiality in geometric shapes, in proportioned heights and tonal colours. Bearing the weight of the architectural conception of this new system, are two different versions of legs: a single, closed horizontal block, bringing to mind a podium; and another higher one, made up of four squared, metal legs, as if they were the columns of a portico.

## MATERIALS AND FINISHES

Cabinets: embossed lacquered mdf.  
Structure: anthracite painted metal.

Each cabinet can be in one of these colours.  
Ogni contenitore può essere in uno di questi colori.

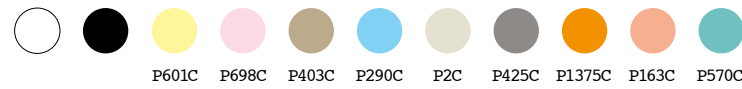

Lay-on cabinets / Contenitori in appoggio

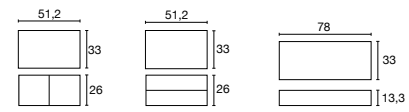

Cabinet with feet or base / Contenitore con piedini o base

### CABINET 1

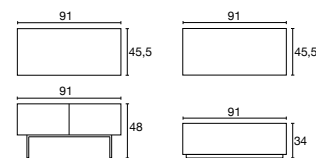

### CABINET 2

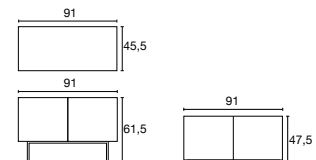

### CABINET 3

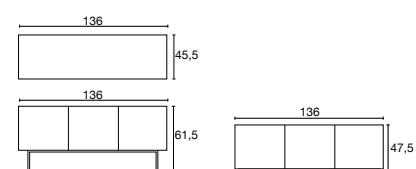

Toshi, che in giapponese significa città, è un sistema di mobili contenitori che richiama le decorazioni a mosaico presenti in alcuni edifici di Tokyo. La forma pulita ed essenziale risalta e valorizza il disegno geometrico inciso sulle ante dei mobili. A ogni tipologia di madia -distinte per le dimensioni- è associato un pattern specifico che rende unico il modulo. Il richiamo all'architettura giapponese è evidente: una micro città che sviluppa la sua essenzialità nelle forme geometriche, nelle altezze proporzionate e nei colori tonali. A dare supporto alla concezione architeturale della nuovo sistema, due versioni di gambe: una unica orizzontale chiusa a zoccolo, a richiamo dei podi degli edifici; e una più alta, fatta da quattro gambe in metallo a sezione quadrata, come se fossero le colonne di un porticato.

## MATERIALI E FINITURE

Contenitori: mdf laccato gofrato.  
Struttura: metallo verniciato antracite.



### CABINET 4

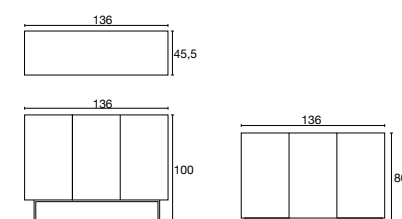

### CABINET 5

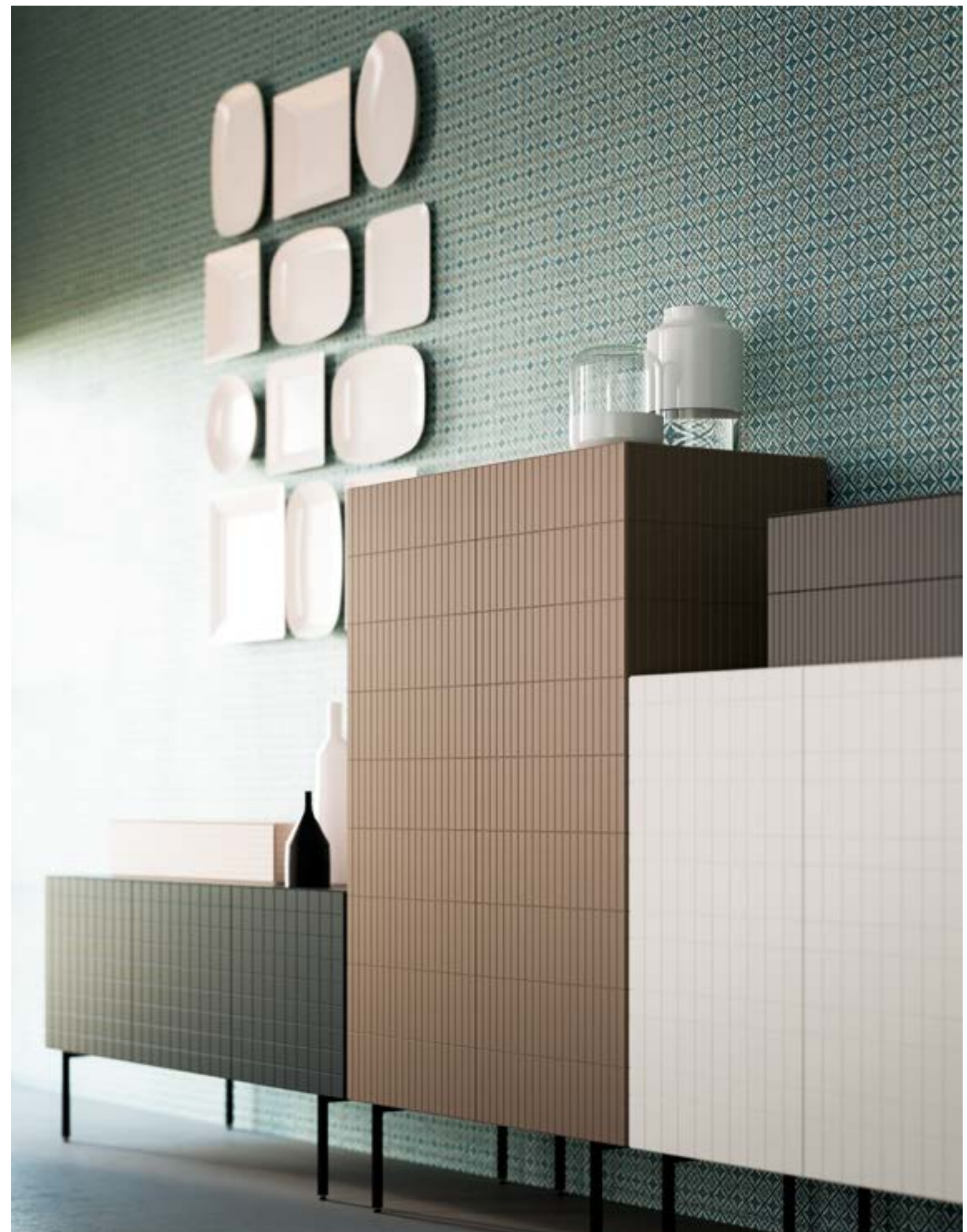
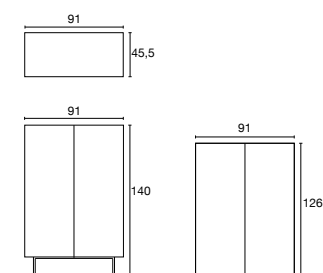



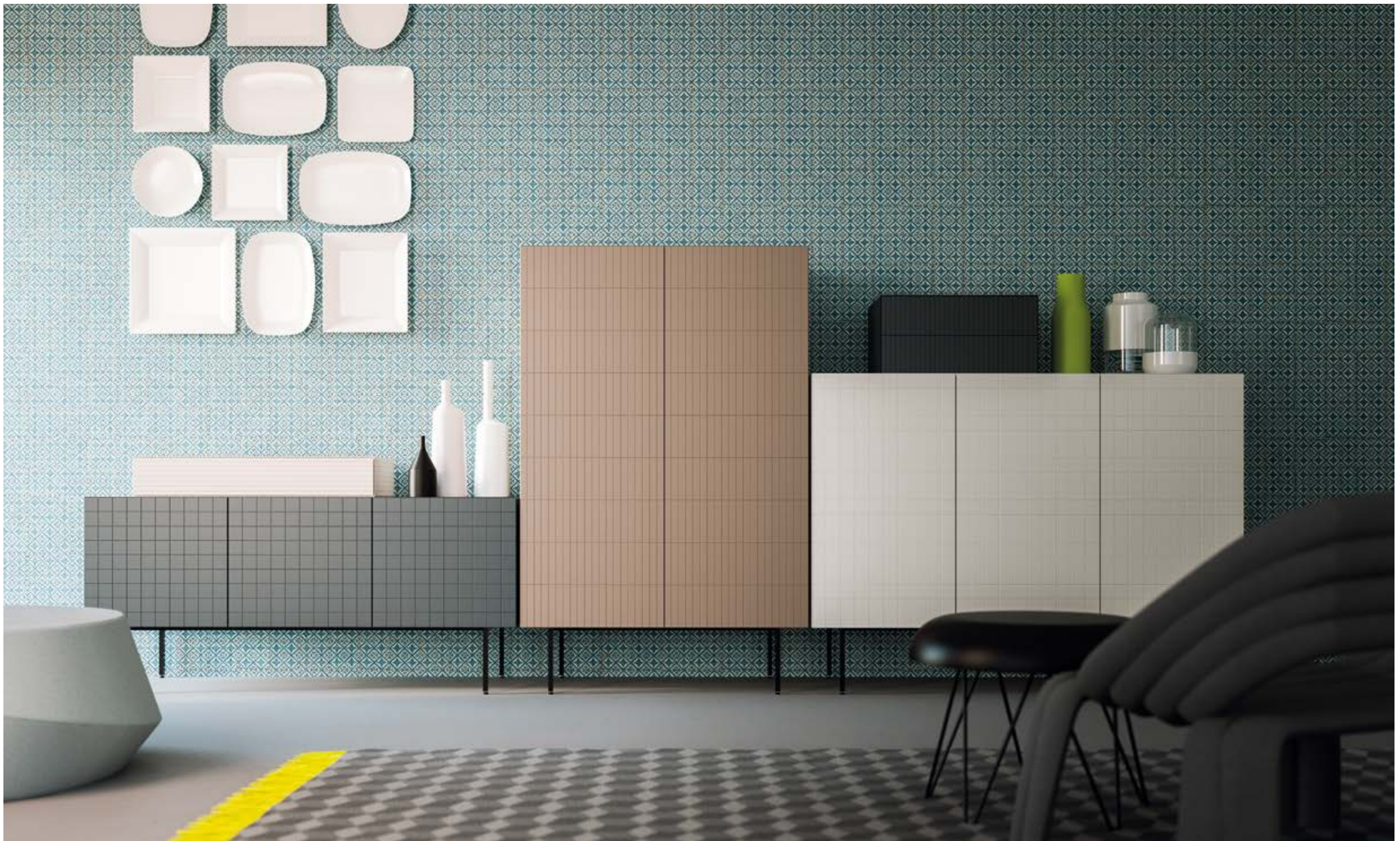



# VALISES

design Maarten De Ceulaer  
2008

A modular system rich in poetry. Valises combines to form a complete wardrobe system created to safeguard garments, shoes and accessories in style. The various 'suitcase' modules are covered in recycled leather. Valises is a nod to the elegance of by-gone eras with a modern and fun twist. The design evokes the luxurious atmosphere of stylish leather suitcases. The wardrobe is an assemblage of six modules, each specifically designed to accommodate a type of garment. A puzzle that provides a place to store your most beautiful suits or dresses, your most precious shoes, your loveliest hats, The design wanted to design a dynamic and flexible storage system, the opposite of those big and heavy wardrobes, which are difficult to transport.

## MATERIALS AND FINISHES

"Full-grain" hide.

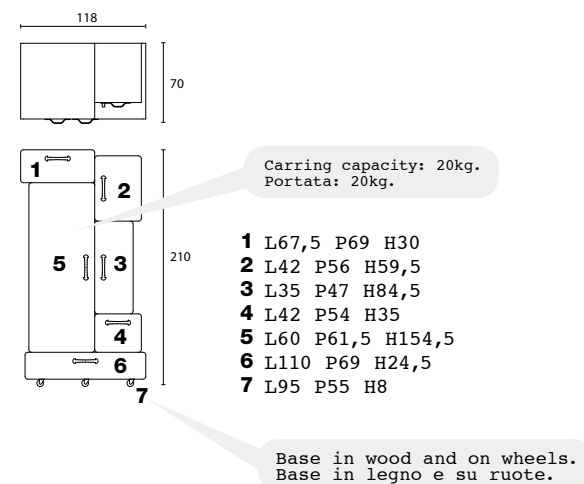

\* Valises can be customized with different colours of leatherette or fabric.  
Valises is transported on pallet.  
6 Cartons containing 7 modules.

È possibile personalizzarlo nei colori e nei tessuti.  
Viene spedito su pallet 6 colli (7 moduli).



Sistema modulare ricco di poesia, Valises offre una soluzione originale per sistemare con stile vestiti, scarpe ed accessori. I vari moduli a forma di valigia sono rivestiti in cuoietto. Valises ripropone l'eleganza del passato, rivisitandola in chiave moderna e divertente. Il progetto mira ad evocare il fascino lussuoso della maglieria in pelle. Il mobile è composto da 6 'moduli', ognuno creato appositamente per accomodare i vari generi di abbigliamento. Un puzzle perfetto per ospitare i vestiti più belli, le scarpe più preziose e gli adorati cappelli di ognuno. L'idea del designer è quella di creare un sistema dinamico e flessibile, antitetico ai tradizionali armadi grandi, pesanti e difficili da trasportare.

## MATERIALI E FINITURE

Cuoio "pieno fiore".







# REMEMBERME collection

design Tobias Juretzek  
2011

It is a race towards the future and the desire to keep the past alive which coexist in Rememberme. The mirror gives us a picture of the present while it is surrounded by lived history. This synergy results in a very poetic expression. It is made by jeans and cotton t-shirts mixed with a special resin. The mirror is provided with holes placed horizontally and vertically in order to facilitate wall fastening in the desired position.

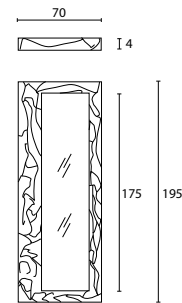
**MATERIALS AND FINISHES**  
Jeans and cotton t-shirts.



 The mirror can be hang or supported. It can be customized with jeans and Cotton t-shirt provided by the customer. To produce the mirror with only jeans are necessary 7kg of jeans. To produce the mirror with jeans and cotton t-shirt are necessary about 4kg of jeans and 3kg of cotton t-shirts. The colours of the t-shirt and of the pair of jeans, may vary from the original ones due to the treatment to wich they are subjected to.

La specchiera può essere appesa o appoggiata. Può essere personalizzata con jeans e t-shirt in cotone forniti dal cliente. Per la versione solo jeans sono necessari circa 7 kg di jeans. Per la versione jeans e t-shirt sono necessari circa 4 kg di jeans e 3 kg di t-shirt. I colori delle magliette in cotone e jeans possono variare rispetto al colore iniziale a causa della lavorazione che subiscono.

Lo slancio verso il futuro e la volontà di mantenere vivo il passato convivono in Rememberme. Lo specchio restituisce un quadro del presente, mentre è circondato da storia vissuta. Questa sinergia si traduce in un'espressione poetica. E' realizzato mescolando jeans e t-shirt di cotone con una speciale resina. Lo specchio è provvisto di fori posti in orizzontale e in verticale per favorire il suo fissaggio a muro nella posizione desiderata.

**MATERIALI E FINITURE**  
Jeans e magliette in cotone.

**1** Jeans + t-shirt are treated with the resin. Jeans + t-shirt vengono trattati con la resina.



**2** They are inserted into the mould. Vengono inseriti nell'apposito stampo.



**3** Jeans + t-shirt and resin are allowed to dry. Jeans + t-shirt e resina vengono lasciati asciugare.

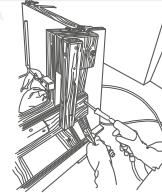

**4** Your mirror is ready. Il tuo specchio è pronto.

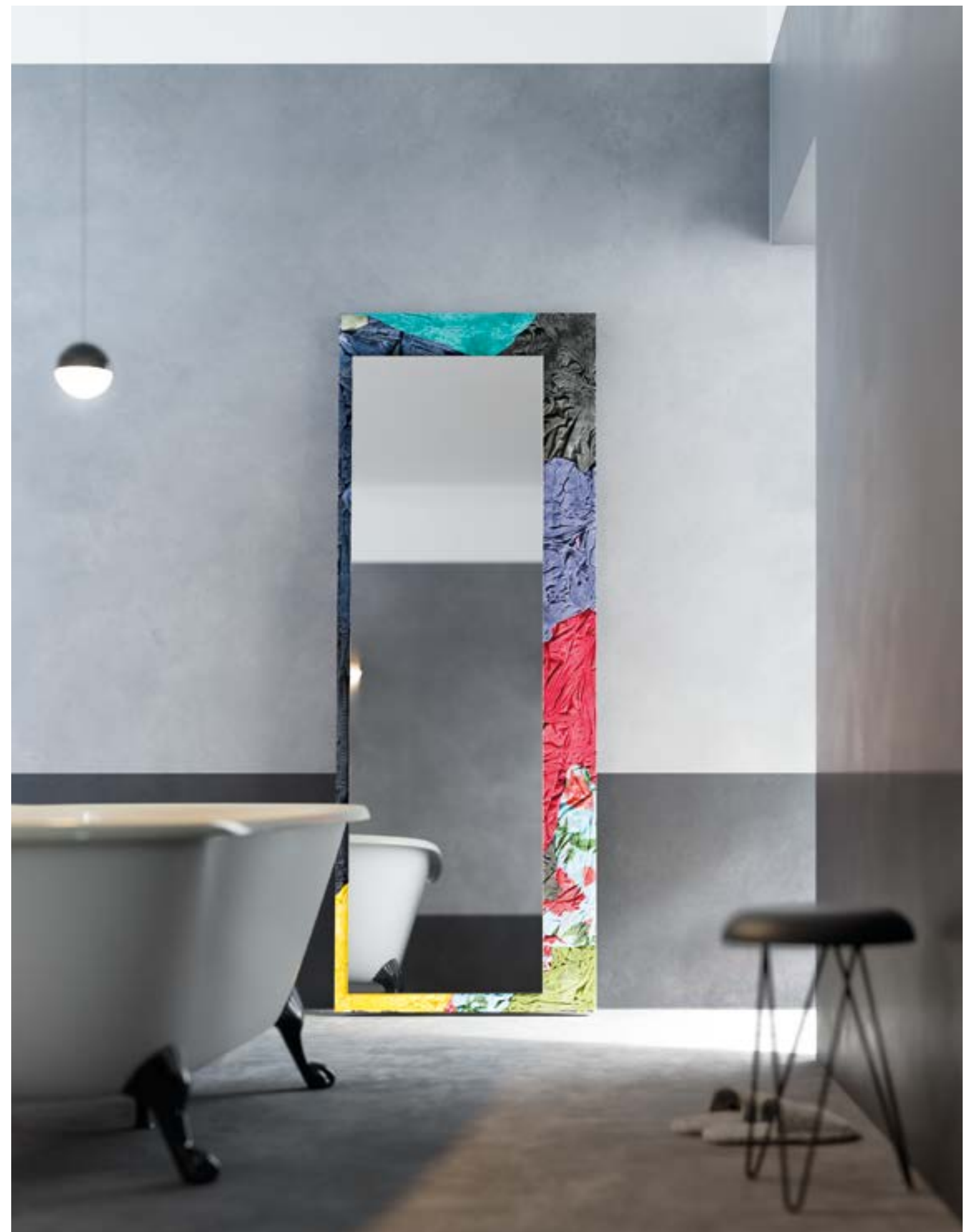





# MARIA

design **Luca Nichetto**  
2007

Used as decoration for environments and shopwindows or as a screen inside a room, Maria is suitable both for indoor and outdoor. Its crochet work texture of Venetian inspiration reproduces the leaf grain, a relationship between natural and artificial with a screen function.

## MATERIALS AND FINISHES

Polypropylene.  
Kit for hanging + 2 m steel wire.

   42 leaves = 1 mq.  
42 foglie = 1 mq.

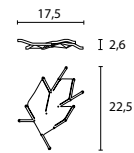

Impiegata come decoro per ambienti e vetrine di esposizione o come separé all'interno di una stanza, Maria è adatta anche all'esterno. Le decorazioni a "merletto - uncinetto" di ispirazione veneziana riproducono le venature della foglia in un'unione tra naturale e artificiale con funzione di schermatura.

## MATERIALI E FINITURE

Polipropilene.  
Kit tenditore + filo acciaio 2mt.









# FESTIVAL

design Baldanzi & Novelli  
1987

Festival is a modular system created in order to contain, classify, file and organize internal and external spaces. Festival furnishes houses, offices, shops, stands, communities (libraries, archives, hotels) etc. A completely sectional modular system thanks to which any sort of module can be created of varying width, height and with three depths. The structural elements can be overlapped using a special plastic joint completed by a series of practical storage units and useful accessories.

Festival system it has been developed for home, wardrobe, mediateque.

## MATERIALS AND FINISHES

Structure: side element in embossed grey or white painted metal.  
Shelves: microperforated metal shelves in embossed silver or white paint; white or grey melamine.  
Cabinets: white or grey melamine.  
Accessories: metal or plastic.

Festival è un sistema modulare studiato per contenere, stivare, archiviare e organizzare spazi interni e aperti. Arreda case, uffici, negozi, stands, comunità (biblioteche, archivi, alberghi) etc. Un sistema completamente componibile grazie al quale è possibile creare moduli a piacere sviluppandoli in larghezza, in altezza in profondità. Gli elementi strutturali sono sovrapponibili tra loro per mezzo di un giunto realizzato in materiale plastico completando il sistema con una serie di pratici contenitori ed utili accessori.

Il sistema Festival viene inserito in tre contesti diversi: casa, cabina armadio, mediateca.

## MATERIALI E FINITURE

Struttura: montanti in tondino di metallo verniciato grigio o bianco gofrato.  
Piani: metallo microforato verniciato bianco o grigio gofrato; melaminico bianco o grigio.  
Contenitori: melaminico bianco o grigio.  
Accessori: metallo o plastica.

\* For further information please consult systems catalogues  
Per maggiori informazioni consultare il catalogo sistemi.









## WEB SYSTEM

design Menguzzato & Nascimben  
2001

Web System is a versatile modular system characterized by a particular stem in polished or painted aluminium. The system allows to create elegant lounge compositions, library-archives, walk-in closets, and so on. It can be used on both ceilings and walls.

### MATERIALS AND FINISHES

Structure: polished aluminium or white painted aluminium.  
Shelves: white melamine, silver or white painted metal.  
Drawers: White melamine.  
Cabinets: White melamine.



For further information please consult systems catalogues  
Per maggiori informazioni consultare il catalogo sistemi.

Web System è un eclettico sistema modulare caratterizzato da un particolare stelo in alluminio spazzolato lucido o verniciato. Il sistema permette di realizzare eleganti composizioni da salotto, archivi-libreria, cabine armadio, ecc. E' utilizzabile sia a soffitto che a parete.

### MATERIALI E FINITURE

Struttura: alluminio spazzolato lucido o verniciato bianco.  
Ripiani: melaminico bianco o metallo verniciato argento o bianco.  
Cassetti: melaminico bianco.  
Contenitori: melaminico bianco.





## FLUKSO - EXTREMA AU

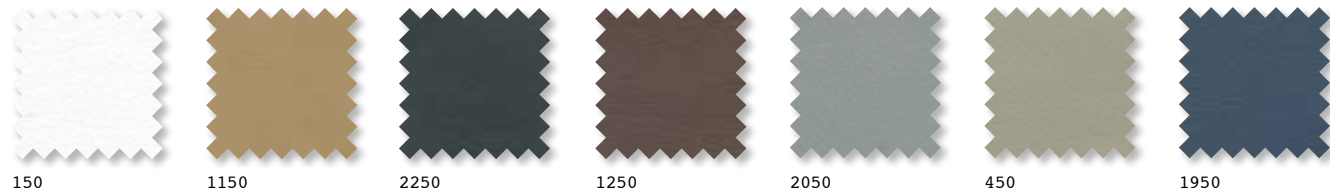

### flukso.it

Weight (g/ml): 670±5%  
 Weight (g/m²): 480±5%  
 Height (cm): 140±2%  
 Composition: 63% Polyurethane 37% Cotton  
 Abrasion resistance: UNI EN ISO 12947-2:2000 150,000 cycles  
 Martindale Light fastness: UNI EN ISO 105 B02:2001 (Xenotest) 5-6 (blue scale)  
 Perspiration resistance: UNI EN ISO 105 E04:98 Acid alkaline 4-5  
 Treatment: Antibacterial, anti dust mite ULTRA-FRESH  
 Colour: slight differences in colour between batches are possible  
 Maintenance method: Dust gently and if there are slight stains clean the surface with a damp cloth or a neutral detergent solution then rinse with water. For concentrated and more stubborn stains (grease, oil, make up, ink, coffee, liqueur, chewing-gum etc.) loosen the stain at the proper time with 20% ethyl alcohol (colourless liquid) diluted in water, dab and then treat with a neutral detergent solution, rinsing well.

Peso (g/ml): 670±5%  
 Peso (g/m²): 480±5%  
 Altezza (cm): 140±2%  
 Composizione: 63% Poliuretano 37% Cotone  
 Resistenza all'abrasione: UNI EN ISO 12947-2:2000 Martindale 150.000 cicli  
 Solidità colori alla luce: UNI EN ISO 105 B02:2001 (Xenotest) 5-6 (scala dei blu)  
 Solidità al sudore: UNI EN ISO 105 E04:98 Acido alcalino 4-5  
 Trattamento: ULTRAFRESH Antibatterico Antiacaro  
 Colore: sono possibili leggere differenze di colore tra una partita e l'altra  
 Metodo di manutenzione: spolverare delicatamente e in caso di macchie lievi passare la superficie con un panno umido o con una soluzione di detergente neutro, risciacquare con acqua. Per le macchie localizzate e più ostinate (chewing-gum, olio, cosmetici, inchiostro, caffè, grasso, liquori, ecc.) sciogliere tempestivamente la macchia con alcool etilico (liquido incolore) diluito in acqua al 20% tamponare e trattare successivamente con una soluzione di detergente neutro, risciacquare bene.

Flammability: UNI 9175:1987 + A1:1994 CLASSE 1IM - (GB)CRIB 5 -EN 1021/1-2

Reazione al fuoco: UNI 9175:1987 + A1:1994 CLASSE 1IM - (GB)CRIB 5 -EN 1021/1-2

## KVADRAT - STEELCUT 2

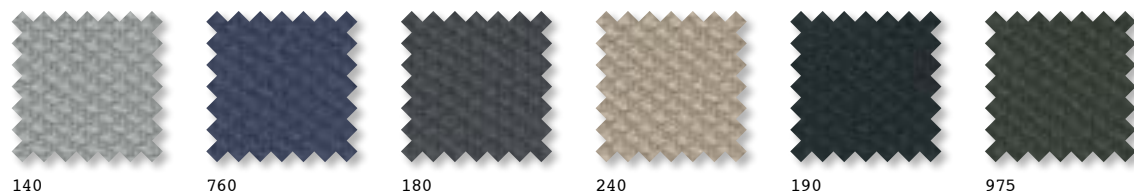

### kvadrat.dk

Application: Offices, hotels, institutions, domestic use. Great durability.  
 Description: 90% new wool, worsted. 10% nylon. Width app. 55 inches (140 cm).  
 Weight app. 825 g/lin.m. Piece dyed. Foreign fibres may occur in light colours.  
 Colour differences may occur.  
 Selvedge }  
 Tests: Abrasion app. 80,000 rubs acc. to the Martindale method EN ISO 12947.  
 Lightfastness (ISO) 5-7. Pilling (EN ISO) 3-4. Fastness to rubbing (ISO) dry 4-5, wet 4.  
 Flame resistance: EN 1021-1/2. BS 5852 ignition source 2-3. ÖNORM B1/Q1. NF D 60 013. US Cal. Tech. Bull. 117. NFPA 260. IMO A.652(16). Crib 5 when flame protected (copy of test report available).  
 Care please see the ISO symbols.

Destinazione d'uso: Rivestimenti per imbottiti, casa e contract. Alta resistenza all'abrasione.  
 Caratteristiche: 90% lana vergine, pettinata. 10% nylon.  
 Altezza circa 140 cm. Peso circa 825 gr/mtl. Tinto in pezza. Nei colori chiari possono essere presenti fibre di tonalità scure. Possibili differenze per colore.  
 Cimosa }  
 Test: Resistenza all'abrasione circa 80.000 cicli/metodo Martindale EN ISO 12947.  
 Resistenza alla luce (ISO) 5-7. Pilling (EN ISO) 3-4. Resistenza allo sfregamento (ISO) condizione a secco 4-5, condizione umido 4. Ignifugazione: UNI 9175 1IM. EN 1021-1/2. BS 5852 sorgente 2-3. ÖNORM B1/Q1. NF D 60 013. US Cal. Tech. Bull. 117. NFPA 260. IMO A.652(16). È possibile ottenere la classe Crib 5 dopo speciale trattamento antiinfiammante (disponibile copia del test).  
 Manutenzione: per favore seguire simboli ISO.



## FEBRIK - UNIFORM MELANGE

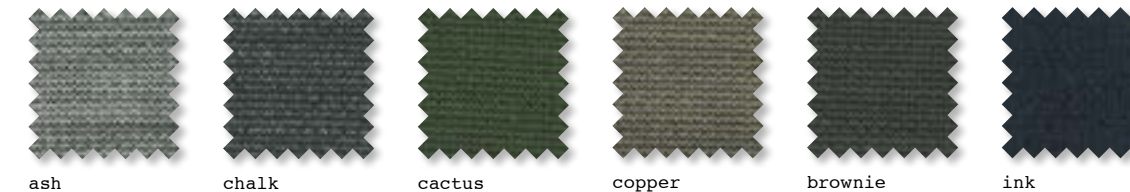

### febrik.com

Composition: 68% wool / 22% polyamide / 10% polyester  
 2,0 mm - 28kg/m3 flame retardant  
 PU foam with a backing knit.  
 Weight: 490 gr/m²  
 Width: 165 cm  
 Number of colours: 38  
 Colours by FEBRIK  
 Abrasion: > 80.000  
 Pilling: 4 (5.000)  
 Colour fastness to light: 6  
 Colour fastness to rubbing: dry 4 - 5 / wet 4 - 5  
 Flame resistance: EN 1021-1/2, BS 5852 part 1, DIN 4102 surface B2, US Cal. Tech. Bull. 117, IMO FTP Code part 8.



## DANI - VINTAGE



### gruppodani.it

Technical sheet  
 Raw Material: European raw hides  
 Tannage: Chromium salt  
 Leather Types: Aniline - Full Grain - Through dyeing aniline  
 Thickness: 1,1-1,3  
 Color fastness:  
 Dry rub fastness - 50 cycles UNI EN ISO 11640. Wet rub fastness - 20 cycles UNI EN ISO 11640. Alkaline solution rub fastness - 20 cycles UNI EN ISO 11640.  
 Fastness to light UNI EN ISO 105-B02.  
 Physical characteristics:  
 Tear strenght UNI EN ISO 3377-1. Flammability - Cigarette test UNI EN 1021-1. Flammability - Match test UNI EN 1021-2. Our leather is processed in conformity with REACH regulation.  
 Cleaning and maintenance:  
 Avoid placing leather near direct sun  
 Keep the leather away from heat sources  
 Dust regularly with a soft and dry cloth

Caratteristiche tecniche:  
 Materia prima: Pelle Bovina di origine Europea.  
 Concia: Ai sali di Cromo.  
 Tipologia: Anilina - Pieno Fiore - Tintura all'anilina passante in botte.  
 Spessore: 1,1-1,3  
 Test solidità del colore:  
 Solidità del colore allo strofinio a secco - 50 cicli UNI EN ISO 11640. Solidità del colore allo strofinio a umido - 20 cicli UNI EN ISO 11640. Solidità del colore allo strofinio con sudore alcalino - 20 cicli UNI EN ISO 11640. Solidità del colore alla luce artificiale UNI EN ISO 105-B02.  
 Test fisici:  
 Resistenza alla lacerazione - Strappo singolo UNI EN ISO 3377-1. Infiammabilità - test della Sigaretta UNI EN 1021-1. Infiammabilità - test del Fiammifero UNI EN 1021-2.  
 L'articolo è realizzato nel rispetto della direttiva REACH  
 Pulizia e manutenzione:  
 Evitare la luce diretta del sole  
 Evitare l'esposizione a fonti di calore  
 Spolverare regolarmente la pelle con un panno morbido ed asciutto



## DANI - FLORIDA

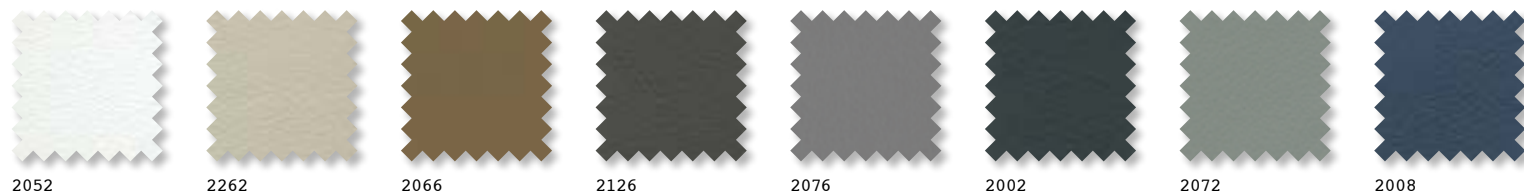

2052 2262 2066 2126 2076 2002 2072 2008

## gruppodani.com

Chrome tanned bull hides with European origin  
Pigmented, corrected grain, through-dyeing aniline  
Thickness: 1.2-1.4 mm  
Range of 100 colours

Physical tests:

Light fastness:  $\geq 6$  blue scale UNI EN ISO 105-B02  
Dry rub fastness 1000 cycles val.  $\geq 4$  grey scale UNI EN ISO 11640  
Wet rub fastness 250 cycles val.  $\geq 4$  grey scale UNI EN ISO 11640  
Adhesion of finishing  $>2N/10mm$  UNI EN ISO 11644  
Tear resistance  $>20N$  UNI EN ISO 3377-1

Flex resistance 50.000 cycles - no damage UNI EN ISO 5402

Flammability test-ignition source: smouldering cigarette - no ignition UNI EN 1021-1

Flammability test - ignition source: match flame - no ignition UNI EN 1021-2

Chemical tests:

Azo-dyes absent ( $< 30ppm$ ) UNI CEN ISO/TS 17234  
Pentachlorophenol content  $< 5ppm$  UNI EN ISO 17070  
Exavalent chromium content  $< 3ppm$  UNI EN ISO 17075  
Formaldehyde content  $< 150 ppm$  UNI CEN ISO/TS 17226

Small scratches, wrinkles and small imperfections are the evidence of a natural product.

The article Florida has obtained the certification "Leather from Italy - full cycle", which insurances that this item is completely Made in Italy. To maintain the beauty of the leather, please note the following tips:

Avoid placing leather near direct sun

Keep the leather away from heat sources

Dust regularly with a soft and dry cloth

Recommended cleaning instructions:

Spots can be washed off using a lightly damp cloth with mild soap.

Dry immediately after the treatment.

Do not rub. Use a circular motion working toward the centre of the stain.

Pelle bovina di origine europea conciata al cromo

Pigmentata, fiore corretto, tintura all'anilina passante in botte

Spessore: 1.2-1.4 mm

Gamma di 100 colori

Test fisici:

Solidità del colore alla luce:  $\geq 6$  scala blu UNI EN ISO 105-B02

Solidità del colore allo strofinio a secco: 1000

cicli val.  $\geq 4$  scala grigi UNI EN ISO 11640

Solidità del colore allo strofinio a umido: 250 cicli val.  $\geq 4$  scala grigi UNI EN ISO 11640

Adesione della rifinitura :  $>2 N/10 mm$  UNI EN ISO 11644

Resistenza allo strappo :  $>20N$  UNI EN ISO 3377-1

Resistenza alla flessione: 50.000cicli- nessuna

rottura UNI EN ISO 5402

Resistenza al fuoco sorgente di accensione sigaretta : mancata accensione UNI EN 1021-1

Resistenza al fuoco sorgente di accensione fiammifero : mancata accensione UNI EN 1021-2

Test chimici:

Azo-coloranti assenti ( $< ppm30$ ) UNI CEN ISO/TS 17234

Contenuto in PCP  $< 5ppm$  UNI EN ISO 17070

Contenuto in cromo esavalente  $< 3ppm$  UNI EN ISO 17075

Contenuto in formaldeide libera  $< 150ppm$  UNI CEN ISO/TS 17226

L'eventuale presenza di graffi, rughe e piccoli difetti sono garanzia stessa della naturalezza del prodotto.

L'articolo Florida è accompagnato dalla certificazione "Leather from Italy - Full Cycle", che attesta come l'intero ciclo produttivo sia realizzato completamente

negli stabilimenti italiani.

Consigli per mantenere inalterata la qualità della pelle:

Evitare la luce diretta del sole

Evitare l'esposizione a fonti di calore

Spolverare regolarmente la pelle con un panno morbido e asciutto.

Istruzioni per pulire la pelle

Eventuali macchie si possono eliminare usando un panno inumidito con acqua e sapone neutro.

Asciugare immediatamente dopo il trattamento.

Non strofinare, ma tamponare delicatamente dai bordi al centro della macchia.

## PANDORA only for stereo cover / solo per stereo cover

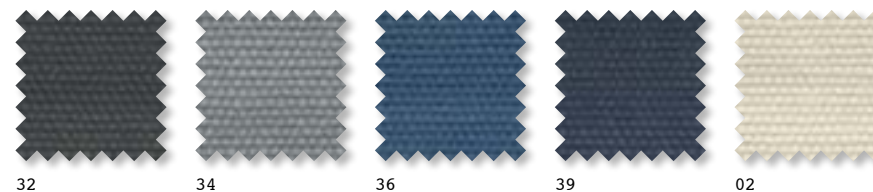

32 34 36 39 02

PANDORA

Application: Offices, hotels, institutions, domestic use.Great durability.

Fields of application: contract furnishing

Material: cotone 100%

Weaving: type Panama with printtype piece dyeing

Weight: (g/m<sup>2</sup>) 300 ( $\pm 5\%$ )

Height: (cm) 140

Abrasion resistance: (N° cycles UNI EN ISO 12947-2 Martindale)

25.000

Pilling: (N° cycles - UNI EN ISO 12945-2 Martindale) 5/2.000

Light fastness:

Colour fastness to light: (UNI EN ISO 105-B02)Blue scale

Colour fastness to rubbing dry and wet: (UNI EN ISO 105x12)

grey scale

Cleaning: do not twist or wring and do not steam iron

Maintenance: Shrinkage water 30° warp -2% welf -1%

Breaking load: warp N 920 welf N 880 UNI EN ISO 13934-1

Extensibility: warp 12% welf 11% UNI EN ISO 13934-1

Sewing resistance: warp 180 N/3 mm welf 180 N/3 mm UNI EN ISO 13936-2

PANDORA

Destinazione d'uso: Rivestimenti per imbottiti, casa e contract.

Settore di applicazione: contract

Materiale: cotone 100%

Tessitura: tipo Panamacon stampa tipo in pezza

Peso: (g/m<sup>2</sup>) 300 ( $\pm 5\%$ )

Altezza: (cm) 140

Resistenza all'abrasione: (N° cicli - UNI EN ISO 12947-2 Martindale) 25.000

Pilling: (N° cicli - UNI EN ISO 12945-2 Martindale) valore medio 5 a 2.000 cicli

Solidità della tinta:

Solidità colori alla luce: (UNI EN ISO 105-B02) scala dei blu

Solidità colori allo sfregamento secco e umido: (UNI EN ISO 105x12) scala di

grigi

Lavaggio: non strizzare o torcere e non stirare a vapore.

Manutenzione: ritiro al lavaggio in acqua 30° ordito -2% trama -1%

Carico alla rottura: ordito N 920 trama N 880 UNI EN ISO 13934-1

Allungamento alla rottura: ordito 12% trama 11% UNI EN ISO 13934-1

Tenuta alla cucitura: ordito 180 N/3 mm trama 180 N/3 mm UNI EN ISO 13936-2

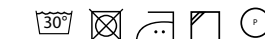

## PLOT only for stereo cover / solo per stereo cover

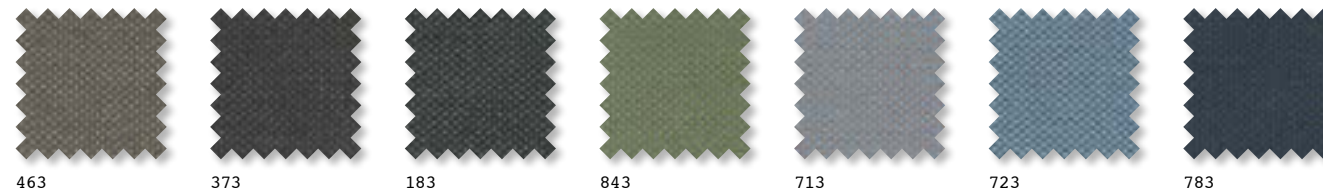

463 373 183 843 713 723 783

## kvadrat.dk

PLOT

Application: Offices, hotels, institutions, domestic use. Great durability.

Description: 100% Trevira. Width app. 55 inches (140 cm). Weight app. 400 g/lin.m.

Yarn dyed. Colour differences may occur.

Selvedge |

Tests Abrasion: app. 45,000 rubs acc. to the Martindale method EN ISO 12947.

Lightfastness (ISO) 6-7. Pilling (EN ISO) 4-5. Fastness to rubbing (ISO) dry 4-5,

wet 4. Flame resistance: EN 1021-1/2. BS 5852 ignition source 5. DIN 4102 Bl. ÖNORM

B1/Q1. SN 198898 5.2. NF D 60 013. NF P 92 507 M1 UNI 9175 11M. UNI 9177 Class 1.

US Cal. Tech. Bull. 117. FAR 25 853 IMO A 6528169(Copy of test report available).

Care please see the ISO symbols. Shrinkage app. 1% when washed at 60°C.

PLOT

Destinazione d'uso: Rivestimenti per imbottiti, casa e contract. Alta residenza

all'abrasione

Caratteristiche: 100% Trevira CS. Altezza circa 140 cm. Peso circa 400 gr/mtl.

Tinto in filo. Possibili differenze per colore.

Cinosa |

Test Abrasione: circa 45.000 cicli/metodo Martindale EN ISO 12947. Resistenza alla

luce (ISO) 6-7. Pilling (EN ISO) 4-5. Resistenza allo sfregamento (ISO) condizione

a secco 4-5, condizione umido 4. Ignifugazione: UNI 9175 11M. UNI 9177 classe 1 EN

1021-1/2. BS 5852 sorgente 5. DIN 4102 Bl. ÖNORM B1/Q1. SN 198 898 5.2 NF D 60 013.

NF P 92 507 M1. US Cal. Tech. Bull. 117. IMO A.652(16)(Disponibile copia del test).

Manutenzione: per favore seguire simboli ISO.

Restringimento: 1% quando lavata 60° C.

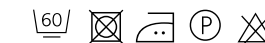



**KVADRT - TONUS 3** only for Nuance / solo per Nuance

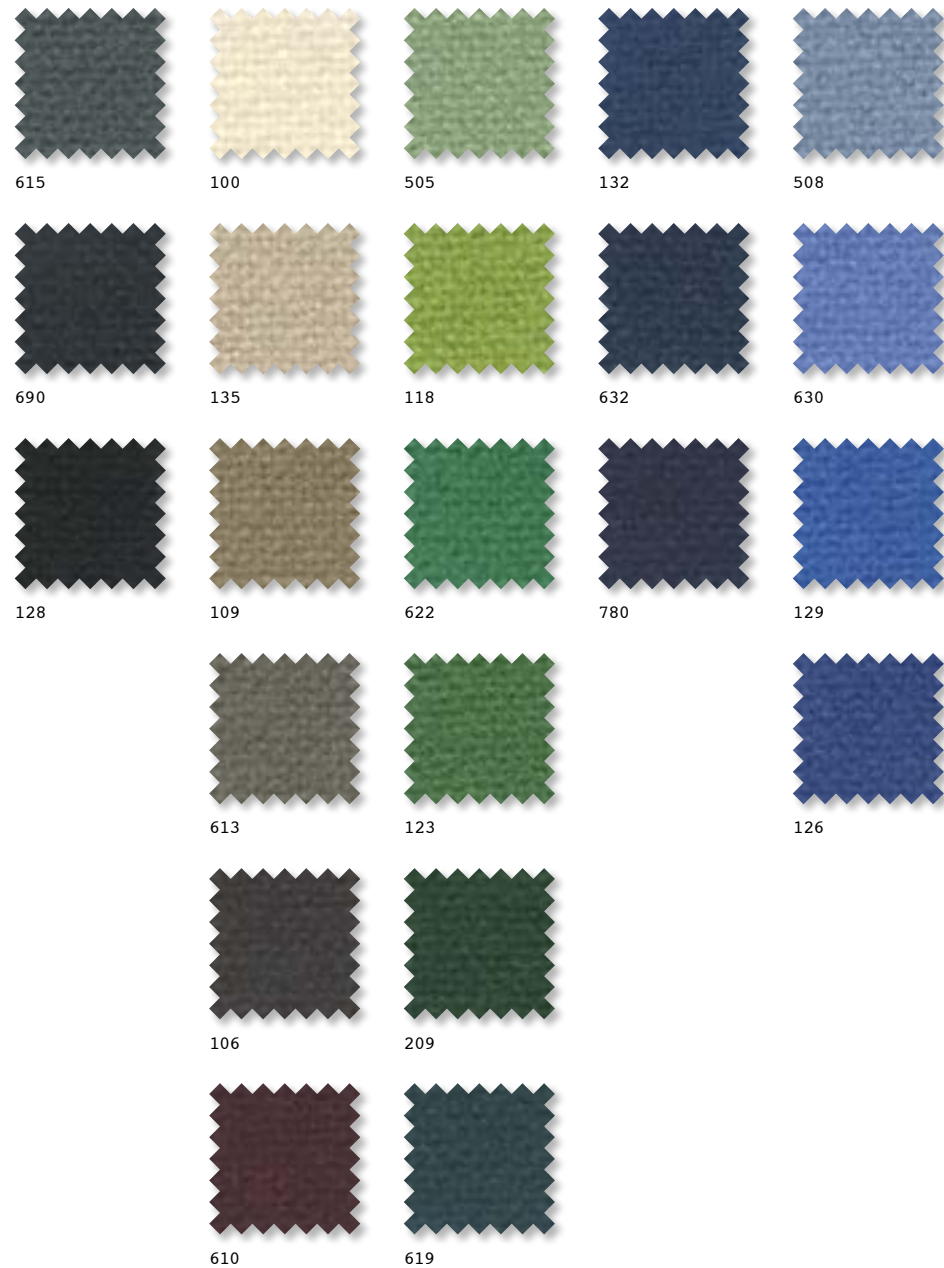

**kvadrat.dk**

Application: Offices, hotels, institutions, domestic use. Great durability and stretchability.  
 Description: 90% new wool. 10% Helanca. Width app.51 inches (130 cm). Weight app. 635 g/lin.m. Piece dyed. Foreign fibres may occur in light colours. Colour differences may occur.  
 Selvedge ↔  
 Tests: Abrasion in excess of 50,000 rubs acc. to the Martindale method EN ISO 12947. Lightfastness (ISO) 5-7. Pilling (EN ISO) 3. Fastness to rubbing (ISO) dry 4-5, wet 4-5. Flame resistance: EN 1021-1/2. BS 5852 ignition source 2-3. ÖNORM B1/Q1. NF D 60 013. US Cal. Tech. Bull. 117. NFPA 260. IMO A.652(16). Crib 5 and B2 when flame protected (copy of test report available).  
 Care please see the ISO symbols.

Destinazione d'uso: Rivestimento per imbottiti casa e contract. Alta resistenza all'abrasione e capacità di stiramento.  
 Caratteristiche: 90% lana vergine. 10% Helanca. Altezza circa 130 cm. Peso circa 635 gr/mtl. Tinto in pezza. Nei colori chiari possono essere presenti fibre di tonalità scure. Possibili differenze per colore.  
 Cimosa ↔  
 Test: Abrasione superiore 50.000 cicli/metodo Martindale EN ISO 12947. Resistenza alla luce (ISO) 5-7. Pilling (EN ISO) 3. Resistenza allo sfregamento (ISO) condizione a secco 4-5, condizione umido 4-5. Ignifugazione: UNI 9175 IIM. EN 1021-1/2. BS 5852 sorgente 2-3. ÖNORM B1/Q1. NF D 60 013. US Cal. Tech. Bull. 117. NFPA 260. IMO A.652(16). È possibile ottenere la classe Crib 5 e B2 dopo speciale trattamento antiinfiammante (disponibile copia del test).  
 Manutenzione: per favore seguire simboli ISO.



**GABRIEL - EUROPOST 2** only for Nuance / solo per Nuance



Fields of application: contract furnishing  
 Material: Pure new wool 100%  
 Weight (g/ml) 800  
 Height (cm) 140  
 Abrasion resistance: (rubs BS EN ISO12947-2 Martindale) 50.000  
 Pilling (scale 1-5, max 5- EN ISO 12945) 4  
 Colour fastness to light: (scale 1-8, max 8 EN ISO 105-B02) 5  
 Colour fastness to rubbing: (scale 1-5, max 5- EN ISO 105x12 wet/dry 4-5  
 Cleaning: dry cleaning P P-cleaning  
 Flammability: EN 1021 1&2 - Calif. Bull. 117E - UNI 9175 Class 1  
 IEMME - BS 5852 P1 s.0&1 - Önorm B3825 B1 3800 -ql uk - imo 4652 (16)-MED certificate IMO  
 Flame retardant performance is dependent upon the foam used.  
 Disegnatore: Gabriel design team  
 Palette: Cenk Kivrikoglu  
 Subject to changes and colour differences.

Settore di applicazione: contract  
 Materiale: Lana vergine 100%  
 Peso (g/ml) 800  
 Altezza (cm) 140  
 Resistenza all'abrasione (giri - BS EN ISO12947-2 (Martindale) 50.000  
 Pilling (scala 1-5, max 5- EN ISO 12945-2) 4  
 Solidità colori alla luce: (scala 1-8, max 8-BS EN ISO 105-B02) 5  
 Solidità colori allo sfregamento: (scala 1-5, max 5- EN ISO 105x12) umido/secco 4-5  
 Lavaggio: lavatura a secco P percloro  
 Comportamento alla fiamma: EN 1021 1&2 - Calif. Bull. 117E - UNI 9175 CLASS 1 I EMME - BS 5852 P1 S 0&1 - Önorm B3825 /A 3800  
 Q1 UK -IMO A.652(16), MED CERTIFICATE IMO  
 Il grado di resistenza al fuoco dipende dal tipo di schiuma utilizzato.  
 Disegnatore: Gabriel design team  
 Palette: Cenk Kivrikoglu



**FEBRIK - RAZZLE DAZZLE** only for cushions / solo per cuscini

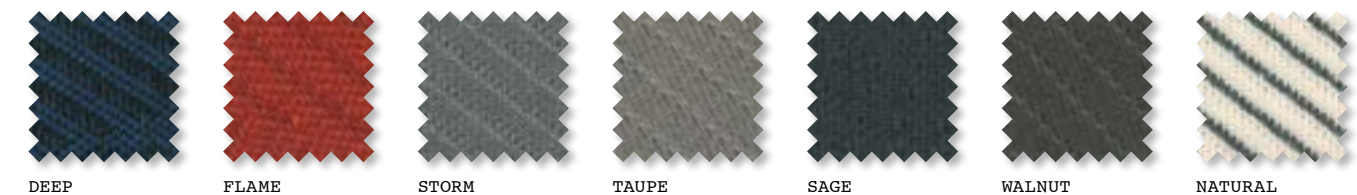

**febrik.com**

Application: contract and domestic not suitable for curtains.  
 Description: 60% wool 20% polyamide 20% polyester. Width 160 cm (+/- 2%). Weight 600 gr/m2 (+/- 5%).  
 Design: Sylvain Willenz  
 Tests: Methode  
 Abrasion: EN ISO 12947-2 martindale  
 Pilling: EN ISO 12945-2 5.000 rubs  
 Colour fastness to rubbing: EN ISO 105-X12 dry / wet  
 Colour fastness to light: EN ISO 105-B02  
 Flame resistance: EN 1021-1/2 cigarette / match  
 BS 5852 part 1 cigarette / match DIN 4102-B2 surface ignition US Cal. Tech. Bull. 117  
 Treatment upon request: flame resistance M1 / Crib 5 soil and stain resistance  
 Environment: Oeko-Tex® standard 100  
 all chemicals used are registered under the REACH legislation  
 ecologically produced in the Netherlands  
 Feature: stretch  
 Notes: slight differences in colour may occur





**NU net medium self-draining fabric / net medium tessuto drenante**

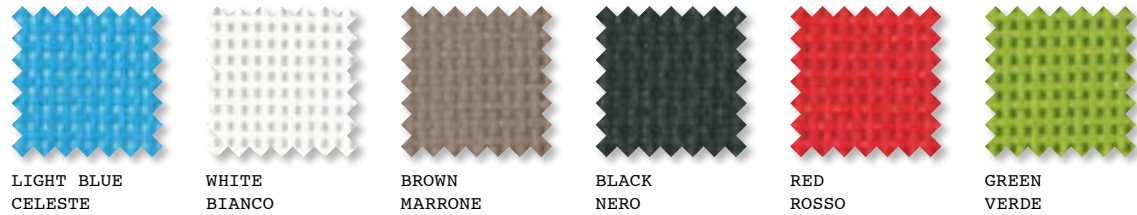

LIGHT BLUE  
CELESTE

WHITE  
BIANCO

BROWN  
MARRONE

BLACK  
NERO

RED  
ROSSO

GREEN  
VERDE

NU  
Warp Weave: 6.10 yarns/cm  
Weft Weave: 5.30 yarns/cm  
Fabric Weight: 560 g/sqm  
Warp Tensile Strength: 310Kg/5cm  
Weft Tensile Strength: 270Kg/5cm  
Thickness: 1.15mm  
Polyvinyl: 70%  
Polyester: 30%

NU  
Costruzione ordito: 6.10 fili/cm  
Costruzione trama: 5.30 fili/cm  
Peso tessuto: 560 gr/mq  
Carico di rottura ordito: 310 Kg/5cm  
Carico di rottura trama: 270 Kg/5cm  
Spessore: 1.15 mm  
Polivinile: 70%  
Poliestere: 30%

**SF similpelle / leatherette only for Morfino and Pollon / solo per Morfino e Pollon**

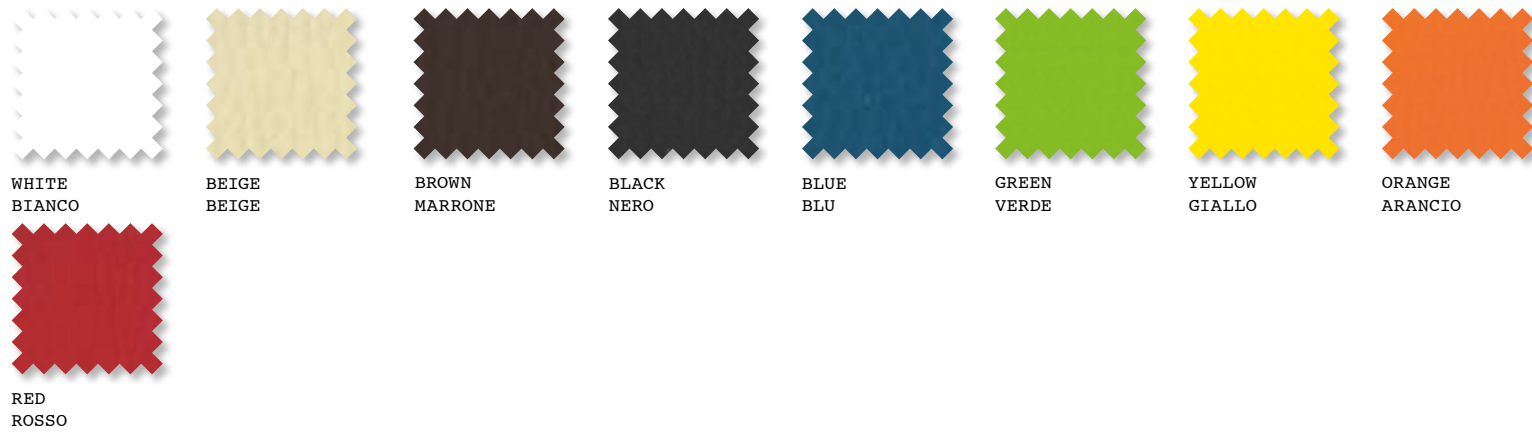

WHITE  
BIANCO

BEIGE  
BEIGE

BROWN  
MARRONE

BLACK  
NERO

BLUE  
BLU

GREEN  
VERDE

YELLOW  
GIALLO

ORANGE  
ARANCIO

RED  
ROSSO

SF  
Fields of application: suitable for everything from cushioning to facing.  
Material: 16% PES 1% PU 83% PVC  
Weight (g/mq) 757  
Height (cm) 140  
Thickness: (mm) 1,4 UNI 4818-74.2°  
Roll length: mt 225  
Abrasion resistance: (cicli) 40.000 UNI EN ISO 12947/1-2 (Martindale)  
Light resistance: (scala 1-8, max 8-UNI 7639/'89) 8  
Tensile strength: N/5 cm long. 237 tras. 280 UNI 4818-74.6°  
Ultimate elongation: long. 70,4% trasv. 110 UNI 4818-74.6°  
Tear strength: N long. 134 trasv. 164 UNI 4818-74.9°  
Seam test: N long. 358 trasv. 330 UNI 4818-11°

SF  
Settore di applicazione: idoneo per tutte le tecniche di imbottitura e rivestimento  
Materiale: 16% PES 1% PU 83% PVC  
Peso: (g/mq) 757  
Altezza: (cm) 140  
Spessore: (mm) 1,4 UNI 4818-74.2°  
Lunghezza rotolo: mt 225  
Resistenza all'abrasione: (cicli) 40.000 UNI EN ISO 12947/1-2 (Martindale)  
Solidità alla luce: (scala 1-8, max 8-UNI 7639/'89) 8  
Carico di rottura: N/5 cm long. 237 tras. 280 UNI 4818-74.6°  
Allungamento rottura: long. 70,4% trasv. 110 UNI 4818-74.6°  
Resistenza lacerazione: N long. 134 trasv. 164 UNI 4818-74.9°  
Resistenza alla cucitura: N long. 358 trasv. 330 UNI 4818-11°



**WOOD /legno**

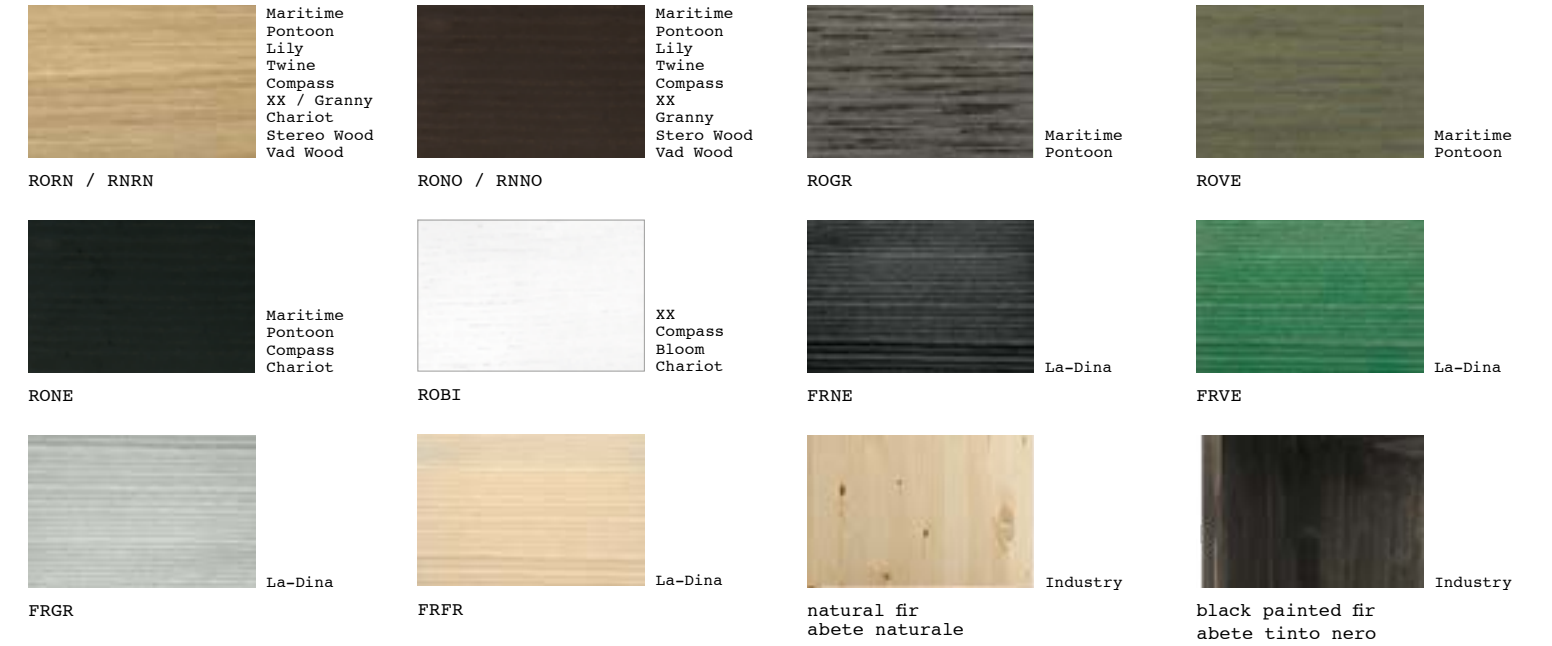

RORN / RNRN

RONO / RNNO

ROGR

ROVE

RONE

ROBI

FRNE

FRVE

FRGR

FRFR

natural fir  
abete naturale

black painted fir  
abete tinto nero

**MELAMINE /melaminico**



MCBI

MCNO

MCRN

**MDF /mdf**



FLBI

FLRE

cement  
cemento



**METAL /metallo**



**ALUMINIUM /alluminio**

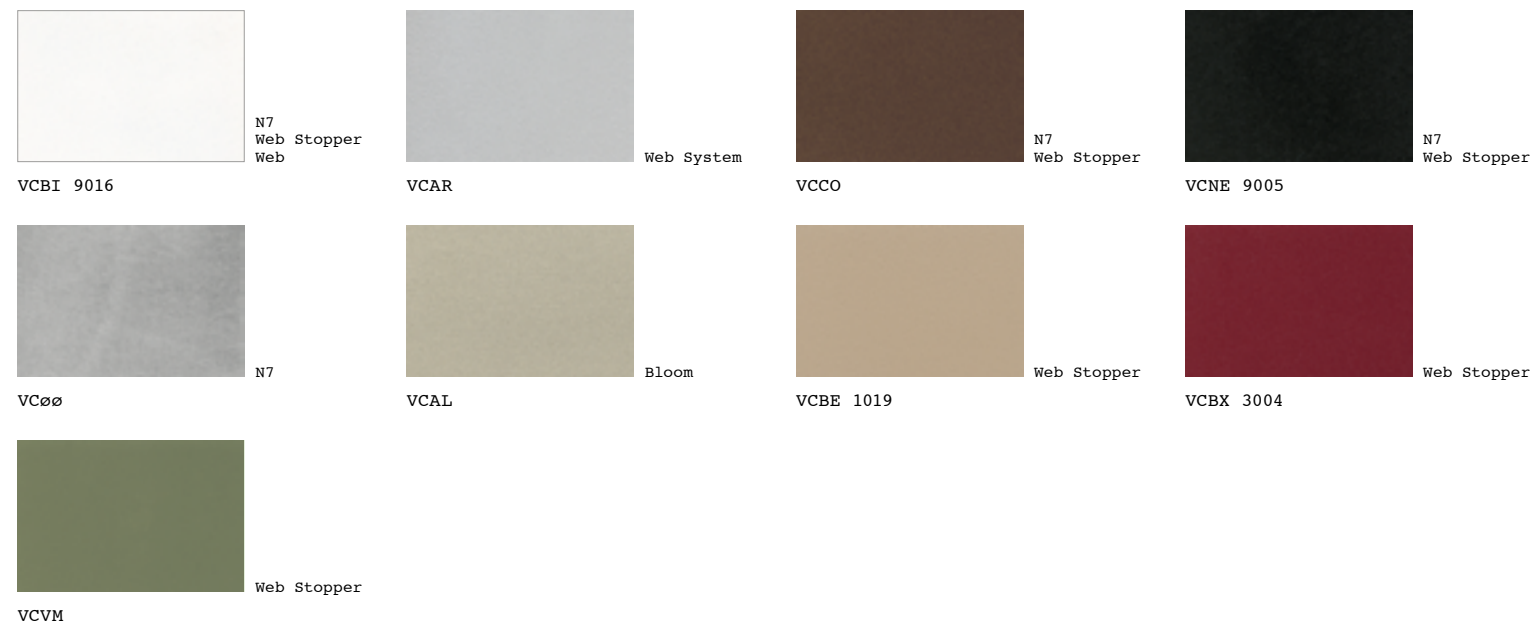

**POLYPROPYLENE /polipropilene**

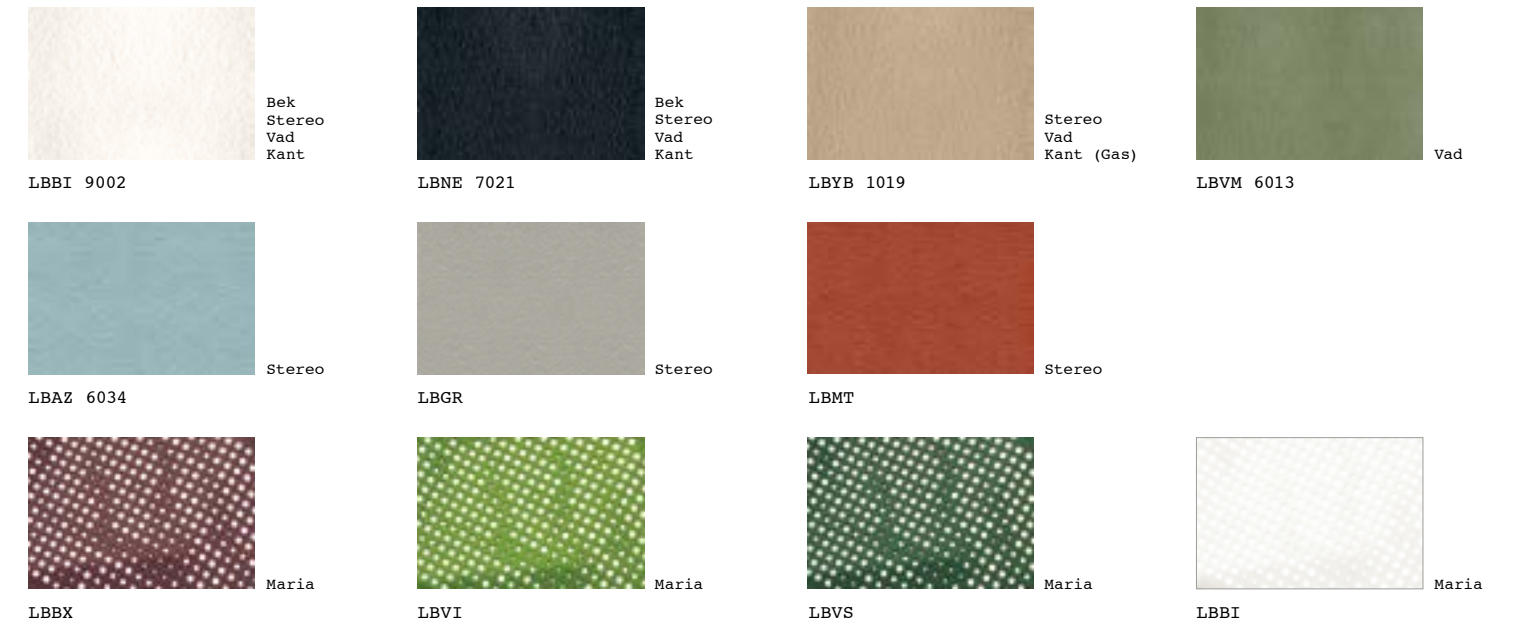

**EXPANDED POLYPROPYLENE /polipropilene espanso**

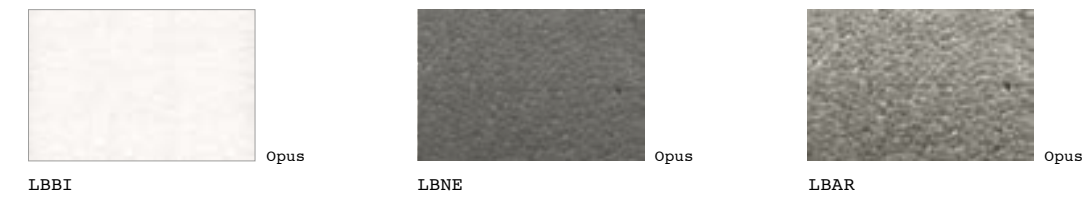

**POLYETHYLENE /polietilene**





---

**POLISHED PAINTED POLYETHYLENE /polietilene verniciato**

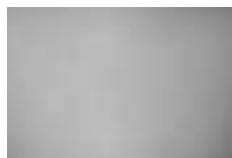

VCAR

Korzina  
Zontik



VCBL

Korzina  
Zontik



VCRM

Korzina  
Zontik



VCVM

Korzina  
Zontik

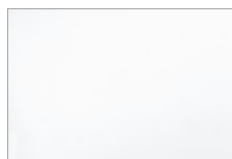

VCBI

Him&Her



VCNE

Him&Her

---

**POLYAMIDE /poliammide**

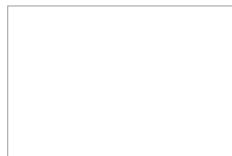

LBBI

Hoo

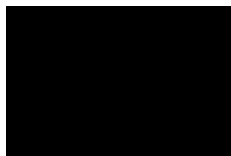

LBNE

Hoo